



Peat sampler

Operating instructions



Meet the difference

Contents

On these operating instructions	3
1. Description	3
1.1 Peat sampler	3
1.2 Edelman auger, combination type.....	4
1.3 Attachments	4
2. Safety instructions	4
3. Use of peat sampler and Edelman auger	5
3.1 Peat sampler	5
3.2 Edelman auger, combination type.....	6
4. Applications.....	7
5. Troubleshooting	7
6. Maintenance.....	7

Nothing in this publication may be reproduced and/or made public by means of print, photocopy, microfilm or any other means without previous written permission from Royal Eijkelkamp. Technical data can be amended without prior notification.
Royal Eijkelkamp is not responsible for (personal) damage due to (improper) use of the product.
Royal Eijkelkamp is interested in your reactions and remarks about its products and operating instructions.

On these operating instructions



If the text follows a mark (as shown on the left), this means that an important instruction follows.



If the text follows a mark (as shown on the left), this means that an important warning follows relating to danger to the user or damage to the apparatus. The user is always responsible for its own personal protection.

1. Description

The standard peat sampler set consists, among other things, of the peat sampler and Edelman auger bottom parts, an upper part with detachable grip, extension rods, push/pull handle, a utility probe and various accessories. To connect these parts a conical screw thread connection is used. The complete set is contained in an aluminium transport case.

1.1 Peat sampler

The stainless steel bottom part of the peat sampler has an auger body consisting of a half-cylindrical sample containing section or "gouge" (1) with a massive cone (2) at its bottom end. The gouge has one cutting edge and is sealed off by a hooked blade or "fin" (3) hinging on the auger body. The blade's top and bottom end's width is identical to the auger's width, but is wider in the middle. The protruding, rounded side has a cutting edge.

The massive cone serves to push aside the soil when the sampler is inserted. At that stage, the blade seals off the gouge. When the auger is given a half turn (180°) to fill the, resistance will cause the blade to remain in position. When the auger is hoisted, the other side of the blade seals off the gouge.

The peat sampler's operational depth is 50 cm. The gouge's diameter is 60 mm, contents ca. 0.5 litre (Sample diameter 52 mm).

The upper part measures 60 cm and has a detachable, synthetic handle. The extension rods measure 1 m.

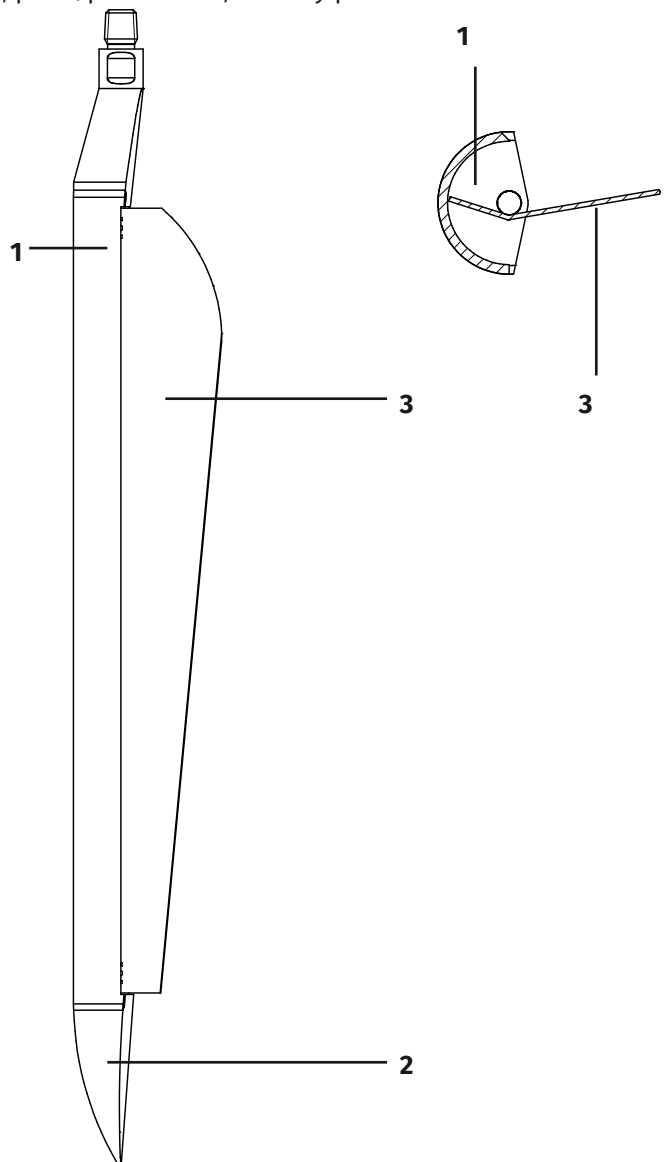

Peat sampler, side view (left) and cross section (right).

1.2 Edelman auger, combination type

The Edelman auger body (see figure) is conical in shape and consists of two blades (1) joined in a cone (2). The top of the blades is welded to a bracket (3), which is connected to the auger rod (4). The blades are vaulted and when entering the soil the sample is dug up and evenly guided into the inside of the auger body. The vaulting of the blades not only promotes digging up but also ensures a firm grip of the sample while permitting easy emptying of the auger body.

The Edelman combination type auger's diameter (measured diagonally between the blades at the broadest part of the auger body) measures 10 cm, the blades measure 50 mm in width. This permits a good hold of moderately cohesive soils, while cohesive soils can easily be removed.

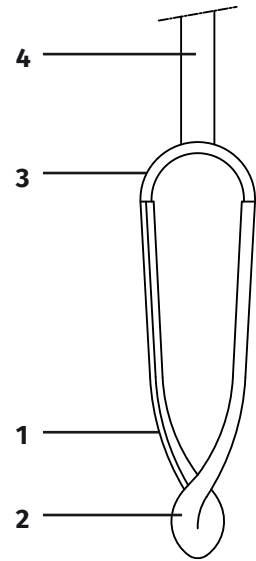

1.3 Attachments

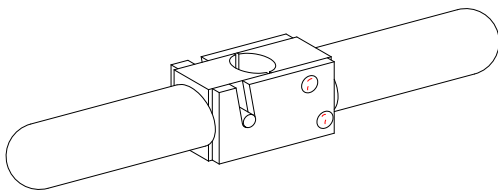

Push/pull handle.

The push/pull handle has two parts that can be fitted around a rod.

Once pressure is exercised on the two bars of the handle its construction ensures a firm hold of the rod.

Utility probe.

The fibre glass utility probe measures 105 cm and has a 19-mm cone diameter. The probe is well insulated; this ensures safely checking the substratum for cables, tubes and pipes in all types of soils.



2. Safety instructions



Prior to augering check for cables, tubes and pipes (inquire at your municipality or other relevant organisations). Use the utility probe to safely check the spot for augering. If necessary, select another spot.



While augering, hold the auger by its synthetic handle. It is fully insulated should you hit an electricity cable.



Do not force, or pound on, the peat sampler. The use of a hammer may cause serious damage. Force may cause torsion of the blade, which may bend or snap.



Augers over 4 m should be handled in parts. This will prevent damage to the rods and reduce the risk of being hit by augers tipping over. This applies to inserting and hoisting the auger.



Be cautious during a thunderstorm. Lightning strokes often occur in the open field, in particular when one holds a metal auger.

3. Use of peat sampler and Edelman auger

3.1 Peat sampler



Prior to augering check for cables, tubes and pipes (inquire at your municipality or other relevant organisations). Use the utility probe to safely check the spot for augering. If necessary, select another spot.

1. Screw the synthetic handle onto the upper part.
2. Attach the bottom part with auger body to the upper part. If necessary, use one or more extension rods. Use spanner 20x22 to tighten the connections.
3. Turn the blade to fully seal off the gouge. The blade's protruding side should cover the flat, non-cutting edge of the gouge.
4. Insert the sampler vertically, without rotating it, into the soil or into the water to a chosen depth. The blade seals off the gouge so as to prevent it from filling up. The massive cone pushes the soil aside. The cutting edge cuts through the soil.

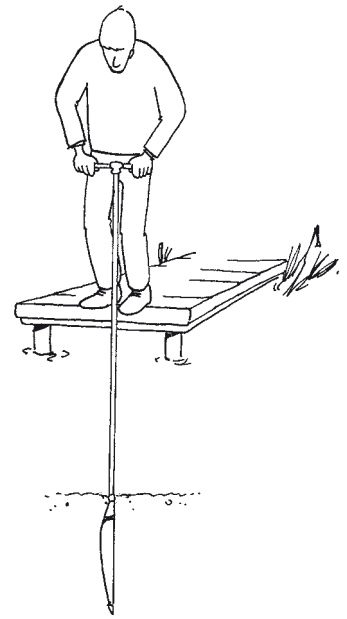

While augering, hold the auger by its synthetic handle. It is fully insulated should you hit an electricity cable.



Do not force, or pound on, the peat sampler. The use of a hammer may cause serious damage. Force may cause torsion of the blade, which may bend or snap.

5. At the chosen depth, give the auger a half turn clockwise. The gouge will make a half circle, pivoting on the blade's hinges. Resistance will cause the blade to remain in position, whereas the gouge cuts through the soil and upon completion of a half circle is fully filled with sample material (see figures below). The blade seals off the sample inside.
6. Hoist the auger vertically; keep your back straight and your knees bent to prevent injuries. The blade fully seals off the gouge, so the sample will not mix with upper soil layers. If necessary, use the push/pull handle to ensure a full grip at a comfortable position.

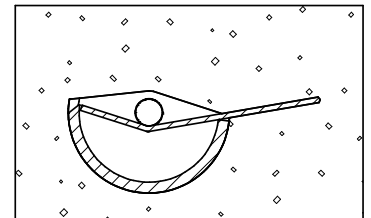

In very weak soils or open water, hoist the sampler while gently rotating it to ensure that the blade remains in position. In addition, in open water the current may cause the gouge to open. Turn the sampler to ensure that the current pushes against the blade.

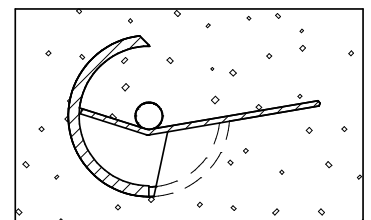

7. Upon withdrawal, lay the sampler flat on the ground, the blade on top of the gouge. Turning the blade a half circle in a horizontal position will clean the gouge, presenting a hardly disturbed sample laid out on the blade.



Augers over 4 m should be handled in parts. This will prevent damage to the rods and reduce the risk of being hit by augers tipping over. This applies to inserting and hoisting the auger.

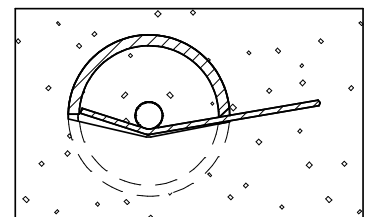



Be cautious during a thunderstorm. Lightning strokes often occur in the open field, in particular when one holds a metal auger.

Some remarks:

- It is possible to auger at any chosen depth to take a sample (a depth-specific sample). Usually, pre-augering to a chosen depth will not be necessary.
- To determine the sampler depth (in particular in open water), it is recommended to apply variable grade marks to the extension rods (an elastic band or sleeve).
- Coarse, fibrous or stony soils may cause the blade not to seal off the gouge well. This may result in loss of sample.
- Resistance incurred upon insertion of the massive cone and of the blade may hamper sampling in stiff soils. The resistance may cause torsion of the auger body, or the blade to bend. In that case, it is advised to pre-auger using the Edelman auger (see paragraph 3.2).



3.2 Edelman auger, combination type

1. Hold the auger by its handle and rest it vertically on the ground (see figure).
2. Upon $2\frac{1}{4}$ rotations (360°), the auger should have dug 10 cm. The auger body will be filled up to its bracket with slightly disturbed soil material. Depending on the type of soil additional rotations may be necessary.



Always rotate clockwise.

3. Cut off the sample rotating a full turn (360°) without pressing down, and hoist the auger while gently rotating it.
4. To release the cohesive material hold the auger askew on the surface (see figure), rotate the auger 180° while pressing it into the ground. The sample should detach itself and can be taken out by hand or by lightly tapping the auger. Moderately cohesive material will detach itself immediately.
5. After pre-augering, the peat sampler can be used for sampling (see figure and paragraph 3.1)

Caution:

- Do not overfill the auger body. Superfluous material will coat the auger hole, which hinders pulling out subsequent soil samples. When augering under the water table an overfilled auger acts like a plunger, which hampers hoisting the auger and results in loss of sample material.
- Loss of sample material. Hoist the auger with sample while lightly rotating it, do not pull it straight out.

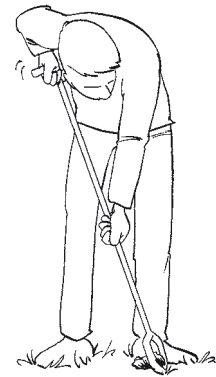
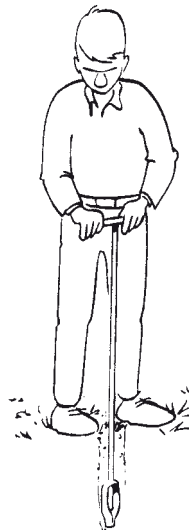

4. Applications

The peat sampler is suitable for use in weak, cohesive soils such as swampy, peaty soils and in subaqueous soils ('sediment'). It may also be used for sampling of powder and granule-like material held in big-bags, lorries and drums. The standard set allows sampling to a depth of 10 m.

The peat sampler can be used for sampling at any chosen depth without pre-augering. In the case of stiff soils (such as clay), pre-augering using the Edelman combination type should precede sampling with the peat sampler.

The peat sampler is applied to take semi-disturbed samples in:

- Environmental studies.
- Soil research in peat (structure, composition of profiles).
- Aquatic botany.
- Paleontological and pollen research.
- Sampling of powder and granule-like materials.
- Filter beds with sand and activated carbon.

5. Troubleshooting

- The peat sampler incurs considerable resistance upon insertion into stiff soil layers (such as clay, sand or gravel) or into coarse fibrous and stony soils. If these layers are top layers, the Edelman auger can be applied for pre-augering.
- Loss of sample occurs during hoisting the peat sampler, caused by the blade badly sealing off the gouge. Coarse, fibrous structures or gravel stuck between the blade and the gouge may be the reason. In this situation, no sampling is possible. Very weak soils or open water may also have caused loss of sample. Hoist the sampler, gently rotating it to ensure that the blade seals off the gouge. In addition, in open water the current may cause the gouge to open. Turn the sampler to ensure that the current pushes the blade against the gouge.
- Sampling may be unsuccessful when the blade incurs insufficient resistance. The peat sampler is not suitable for sampling in weak soils offering insufficient resistance to cut off the sample. In that case, the Multisampler is recommended (available from Royal Eijkelpamp).

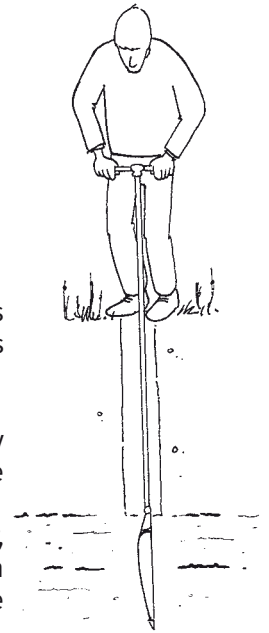

6. Maintenance

- It is recommended to keep the equipment in good condition by rinsing it during use. Use a stainless steel brush to clean the conical thread connections.
- Clean the augers after use with tap water and dry them well. Stow away the equipment in the carrying bag after drying.
- The Edelman auger body needs no whetting, use keeps it sharp-edged. Under normal conditions oxidation is not detrimental to the auger and will vanish upon use. To avoid excessive oxidation when storing the Edelman auger body, apply Vaseline.