

---

User Manual for the

# Moisture Meter

Art. no.: 142602

type *HH2*



Version 4.2

**Eijkelkamp**  
Soil & Water

Nijverheidsstraat 30,  
6987 EM Giesbeek, The Netherlands

**T** +31 313 880 200  
**E** info@eijkelkamp.com  
**I** www.eijkelkamp.com

M-142602E

# Notices

## Copyright

All rights reserved. Under the copyright laws, this manual may not be copied, in whole or in part, without the written consent of Delta-T Devices Ltd. Under the law, copying includes translation into another language.

Copyright © 2017, Delta-T Devices Ltd.

## CE conformity

The Moisture Meter has been assessed for compatibility under the European Union EMC Directive 89/336/EEC and conforms to the appropriate standards. When used in conjunction with a Delta-T soil moisture sensor (such as the Theta or Profile Probes), then the EMC guidelines stipulated in the respective manuals for these sensors should be followed to ensure the combined system remains compliant.

See EMC certificate copy on page 78

## Design changes

Delta-T Devices Ltd reserves the right to change the designs and specifications of its products at any time without prior notice.

## User Manual Version: 4.2

SM150T Soil Moisture sensor added  
PR2 SDI-12 Profile Probe added

Nov 2016

---



Nijverheidsstraat 30,  
6987 EM Giesbeek, The Netherlands

**T** +31 313 880 200

**E** [info@eijkelkamp.com](mailto:info@eijkelkamp.com)

**I** [www.eijkelkamp.com](http://www.eijkelkamp.com)

# Contents

## Quick Start!

1. Unpack - see page 5.
2. Connect the battery or press **Esc** to wake the Moisture Meter if it is asleep.
3. Connect the sensor. The HH2 will assume it is an ML2 ThetaProbe in mineral soil unless you tell it otherwise. Ignore that for now!
4. Put the sensor in soil and press **Read** to read and display a result.
5. Press **Store** to save it.
6. Repeat 4 & 5.

To explore menu options see page 8

To retrieve readings to your PC (This will take a little longer):

- Install and Run **HH2Read** (see page 53)
- Press **Retrieve**, enter a file name and press OK

## About this Manual

Introduction, Unpacking, Parts	page 5
Navigating Options and Readings	page 8
Turn to the separate chapters for	
<b>SM200 &amp; ThetaProbes</b>	page 16
<b>Profile Probes</b>	page 25
<b>WET Sensors</b>	page 35
<b>Equitensiometers</b>	page 45
The rest of the manual has sections on	
Memory management	page 51
HH2Read	page 53
Dataset Import Wizard	page 61
Data File Layout	page 63
About soil parameters a0 & a1	page 67
Linearisation Tables	page 69
Changing the Battery	page 71
Maintenance	page 74
There is a Technical Reference with	
Specifications	page 75
Troubleshooting	page 79
Accessories	page 90
Water Deficit Explained	page 91
Field Water Capacity	page 94
Glossary & Index	page 100

Note the various warnings about changing batteries

# Introduction to the Moisture Meter

---

## Description

The Moisture Meter reads and stores measurements taken with the following Delta-T soil moisture sensors:

- ThetaProbe soil moisture sensor types ML1, ML2 and ML3
- SM series soil moisture sensor types SM150, SM150T<sup>1</sup>, SM200 and SM300<sup>1</sup>
- Profile Probe, types PR1, PR2 and PR2 SDI-12
- Equitensiometer, type EQ2
- WET sensors

The meter can display and store, where appropriate, the following values for the measured readings:

- raw data as millivolt reading (mV)
- soil wetness
- soil water deficit (mm)
- pore and bulk conductivity
- bulk permittivity
- temperature<sup>1</sup>

Equitensiometers can only be read in mV.

Readings include the time and date for later collection from a PC.

Readings may be averaged.

Note: averages cannot be stored for later collection from a PC.

The meter is easy to carry and operate with one hand.

## Connectors

Equitensiometers, ThetaProbes, SM series soil moisture sensors and Profile Probes supplied for use with the HH2 come fitted with a 25-pin connector that plugs in directly.

PR2 Profile Probes have their own separate HH2 connector cable

PR2-SDI-12 Profile Probes have a different HH2 connector cable

Adapters are available for Equitensiometers or probes fitted with 4-pin DIN plugs or 5-pin Tajimi plugs.

Sensors sold with bare wires for connection to loggers need to be fitted with a 25-pin D connector. Either solder it directly, using the type DSK1 adapter kit, or via a junction box type JNC2 connected to a DSK1 via extra cable.



See also: Accessories on page 90.

---





<sup>1</sup> Temperature is **not** read from SM150T or SM300 sensors

# Unpacking

Your consignment will have the following parts:

Part:		Sales code	Description
Moisture Meter		HH2	Moisture Meter with: battery, connector cap, this User Manual & Data Collection software HH2Read (on the Software and Manuals DVD)
RS232 cable with 9-way to 25-way converter		HHRS2	Cable has 9-way D-connectors at both ends. Use 9 to 25 way converter to connect to the Moisture Meter

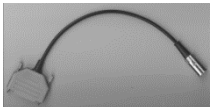
and may also contain some or all of the following:

PR2-HH2 cable		PRC/d-HH2	1.5m cable connects PR2 to HH2
PR2 SDI-12 HH2 cable		SDI-12/5w-HH2	1.5m cable connects PR2 SDI-12 to HH2
Spare battery set		HH2BAT	2 x PP3 Alkaline
DIN to 25-way D socket converter		C-HH2-DIN	Din plug connected to 25-pin female D connector via a short lead.
Tajimi to 25-way D socket converter		C-HH2-T	25-way female D connector fitted with Tajimi socket.
Spares Kit		HH2-SPK	Set of Spares for HH2

# Moisture Meter Parts

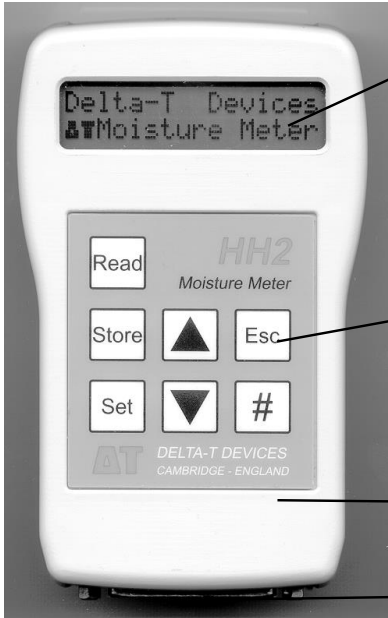

LCD with 2 rows of 16 characters - used to display menus and readings

Keypad	
Read	take readings
Store	save reading
Set	select menu or select option
Esc	wake meter or reject option & go back
▲ ▼	scroll
# #	average

Splash proof case

25-pin D Connector for sensor connection or PC connection



Battery compartment - takes one PP3 battery

---

# How the Moisture Meter takes readings

## **Analogue sensors (SM150, SM150T, SM200, SM300, ML1, ML2, ML3, EQ2, PR1 and PR2)**

The Moisture Meter applies power to the sensor and measures the output signal voltage returned. It displays this directly, in mV, and/or converts into other units, depending on the type of sensor and information available. (Equitensiometer results can only be displayed in mV.) The meter converts the mV reading into soil moisture units using a linearisation table and soil-specific parameters.

Linearisation tables are pre-installed for sensors, along with soil parameters for the following soils: organic, mineral, peat mix, coir, mineral wool and Perlite.

For greatest accuracy you can enter your own soil type parameters - but these have to be determined experimentally. This is outside the scope of this manual.

For mm Deficit you should supply Field Capacity and Root Depth for each soil type and crop.

The date and time is saved with each reading. Before saving readings you may enter a unique Plot, Sample or Device identity (ID) label.

## **Digital Sensor (WET)**

The Moisture Meter applies power to the sensor, receives readings as serial data, processes these (as described in the WET sensor Application Note available from Delta-T), and calculates bulk and pore conductivity, bulk permittivity and temperature as required. Using installed soil calibrations, the HH2 calculates water content. Given the root depth and field capacity it can also calculate mm Deficit.

## **Digital Sensor PR2 SDI-12**

The Moisture Meter Applies power to the SDI-12 Profile probe and takes a reading or the permittivity at each depth, converting this to soil moisture units using an internal calibration table and soil-specific parameters for the following soils: organic, mineral, peat mix, coir, mineral wool, and Perlite. Readings are not available in mV.

## **Sleep and Waking the Meter**

To conserve the battery, the meter will “go to sleep” when it is not used for 1 minute. The display will go blank and the meter will power down to reduce its power consumption.

To make the HH2 sleep, press **Esc** once to return to the banner "Delta-T Devices Moisture Meter" then press **Esc** one more time to make it sleep.

The meter will “wake up” when **Esc** is pressed or when RS232 messages are received from the PC or when the battery is reconnected.

## **Averaging**

Press # to shows the previous average – and press # twice to update it with the current reading. Averages are not stored – sorry. Write it down if you need it.

For details see Averaging on page 13.

# Navigating Options and Readings

Press **Esc** to wake the HH2 and examine the Navigation Map overleaf. There are two main routes - round the Read Cycle, and down (and up) the Options Menus. Individual options or values are set at the bottom level of each menu path. See also the Options Summary at the back of each sensor chapter.

**Not all options are available with all devices.** A table of permitted options, ranges and default values are shown in each sensor chapter.

To display the main **Options** menu press the **Set** key when the readings are visible on the display, or when the start-up screen is visible.



Press **Set** to select an option - this may be another, lower menu.

Press **Esc** to reject an option and backtrack up to the previous menu.

When the **▲** and **▼** symbols are displayed, press the **up ▲** and **down ▼** keys to scroll through the options in any given menu.

To save **Readings** - press **Store**.

To save **Options** - press **Set**.

Press **Read** and **Store** to take and save readings.

## Options Menu

The **◆** symbol indicates that other options are available.

**Data:** Add label for Plot ID, Sample, Device ID, Root Depth, Sensor Depth or delete all data.

**Device:** Select the sensor e.g. PR1 for a Profile Probe.

**Soil Type:** Choose one for each sensor if you want results in engineering units. The default is Mineral.

**Soil Set-Up:** Define parameters associated with each soil type.

**Units:** Select which engineering units are used - e.g. %vol or  $m^3.m^{-3}$ .

**Display:** Select readings to be taken and displayed - e.g. mV and %Vol.

**Date and Time:** The clock can be set via the keypad or from the PC

**Status:** Displays: % memory used, % battery life remaining & number of readings in memory. Also version numbers of firmware and any installed tables.

**Remote:** Select this when connecting to a PC.



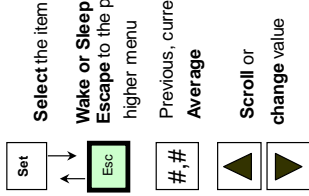
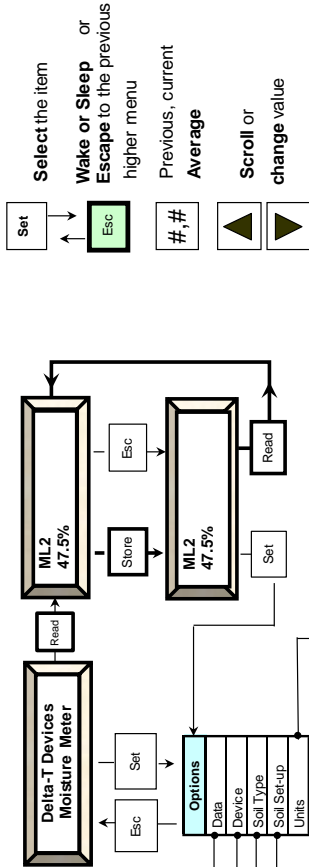

Data
Plot ID
Sample
Device ID
Root Depth
Sensor Depth
Erase

Device
ML1
SM200
SM300
SM50
SM150T
ML2
ML3
ML2 Special
EO2/3
PR2
PR2 SDI-12
PR1
WET

Soil Type
Organic
Mineral
Clay
Sand
Peat mix
Coir
Min. w cool
Perlite
Soil 1
Soil 2
Soil 3
Soil 4
Soil 5

Soil Set-Up
Organic
Mineral
Clay
Sand
Peat mix
Coir
Min. w cool
Perlite
Soil 1
Soil 2
Soil 3
Soil 4
Soil 5

Soil name
Capacity
.a0
.at

Connecting to PC
Resources
Versions

Resources
Mem 100% Batt 97%
Readings #250

Version
Firmw are
ML3 Table
SM150T Table
PR2 Table
WET Callb'h
... etc

Status
Resources
Versions

Date and Time
Set Date
Set Time

Display
m3.m-3
%vol
mm deficit
mV
mm deficit + m3m-3
mm deficit + %vol
m3.m-3 + mV
%vol + mV
mm deficit + mV

Units
m3.m-3
%vol

Note: the availability of options depends on which sensor is selected.

WET options not shown. See WET HH2 Map

---

# Using the Options Menu

Select your **Device** option first - the other options depend on which device has been selected.

---

*Note: before you can select a WET sensor you must install the WET calibration file using HH2Read. (See Install WET Sensor Calibration on page37)*

---

You may specify any **Plot ID** (A - Z), Device ID (0 - 255) and **Sample ID** (1 - 2000) for any reading. These are just labels.

You may choose which engineering **units** to display result.

For soil moisture you must select a **soil type** unless you only want mV readings. (Equitensimeters readings are only available in mV.)

The default soil type is Mineral.

Advanced users, able to calibrate their own soils, may install their own soil specific calibration coefficients called a0 & a1 under **Soil Set-Up**. (b0 & b1 for WET sensors).

Other users should use the Mineral and Organic soils already defined in the Moisture Meter.

WET users have a choice of standard soil types and, if purchased pre-installed in the HH2, custom calibrations for specific commercial artificial soils such as stone wool.

If you want **mm deficit** you MUST define the **Field Capacity** and **Root Depth** for each soil type. We provide a table in the back of this manual for mineral soils. Organic soils are so variable you have to determine the field capacity experimentally, before it makes any sense to take mm Deficit readings.

The default for Field Capacity is pre-set to the 38% corresponding to a silty clay loam. The default Root Depth, set to zero, forces the calculated default value for mm Deficit to be zero. See Calculating Field Capacity on page 96.

Some crop consultants recommend 700 mm as the default Root Depth.

For ease of graphing data it is good to always measure your sensors in the same order each visit.

Some experts recommend having three sensors, or access tubes, at each location, and taking three readings from each, to average out random sampling errors later on your PC.

PR2 users should take three readings at each location by rotating the sensor by 120 degrees.

## Example: Change the Plot Label

The Plot Label is an optional label in the Data sub menu and can take any value from A to Z.

Press **Esc** to wake the meter.

Press **Set** to display the main **Options** menu.

Scroll down to **Data** and Press **Set**.

Scroll down to **Plot ID** and Press **Set**.



In this example, "C" is offered because it was saved with the previous reading.

Press **up**  $\blacktriangle$  or **down**  $\blacktriangledown$  to change the value.

Press **Set** to select the new value.

To reject an option or value press the **Esc**.

In practice you will most probably visit the Data sub menu each time you change your location - to change one or more labels - in order to better identify each reading later.

## Setting the Clock

You can set the clock from the PC or from the keypad of the Moisture Meter.

To set the time in the HH2 to that of your PC use the **Settings, Clock** command in the HH2Read application, (see page 57). Alternatively you can set the clock from the keypad.

Note: The date - month - year order will be set to reflect that on your PC the first time you use the **Settings, Clock** option in the HH2Read.

### To set the clock from the keypad

Press **Set** at the start-up screen to display the **Options** menu.

Scroll down to **Date and Time** using the **up**  $\blacktriangle$  and **down**  $\blacktriangledown$  keys and press **Set**.



Press **Set** to display the Date menu:

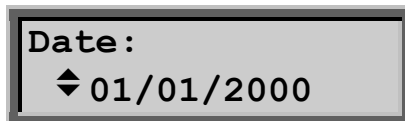

Note that the date - month - year order will be set to reflect that on your PC the first time you use the Settings, Clock option in the Data Collection software HH2Read on your PC.

Use the **up** ▲ and **down** ▼ keys to change the first field and press **Set** to accept it. The ◀ indicator jumps to the next field.

Repeat for the second and third fields in the Date display.

This will return you to the Date and Time menu.

Scroll down to the **Set Time** option with the ▼ key and repeat the above instructions to set the hours, minutes and seconds fields, shown below:

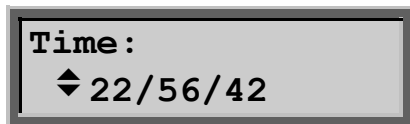

## Options are device specific

Options are only displayed if relevant to the device selected.

For instance, if under device you select Equitensimeter, then you will not be given a choice of Soil Type or Soil Set-Up, or Units.

---

*The default settings in the Moisture Meter are for an ML2 ThetaProbe.*

---

The next section is organised by sensing device. Each has its own menu navigation tree and a table indicating the default settings, available menu options and permitted ranges for settings.

## Upload Data to PC

From the main **Options** menu select **Remote** (or just leave the HH2 switched off (i.e. with a blank screen)).

The rest of the work is done from your PC.

If not yet installed, install HH2Read v2.8 or later on your PC, as described on page 53.

Connect the PC to your Moisture Meter as explained on page 54.

Run **HH2Read** and select its **Retrieve** command as described on page 59.

The end result is that your data is saved to file in a comma separated (.CSV) format as shown on page 63.

See also Dataset Import Wizard on page 61.

---

*Note: you can't store or upload averages to the PC*

---

---

## Averaging

Averaging can provide a quick summary of your plot, greenhouse or treatment.

It is useful for immediate feedback in the field, particularly if you don't want to save data to your PC and analyse it later.

The HH2 provides a single, cumulative average of selected readings.

The average cannot be uploaded to your PC.

Individual readings can be stored and averaged later in a spreadsheet on your PC.

## Summary

1. First take a reading: press **Read**.
2. You will be asked if you want to store the reading.  
Averaging can be done with or without storing the reading.  
Press either **Store** or **Esc**
3. Press the **hash # key** once to display the previous cumulative average.  
(Initially "No Average" is displayed).
4. Press **#** again to update the cumulative average with the current reading (or **Esc** to back out).
5. Write down the final cumulative average if you wish to retain it.
6. To erase the current cumulative average press **Esc** until you return to the main "Delta-T Devices" menu.

## How to average readings

1. First take a reading: press **Read**.

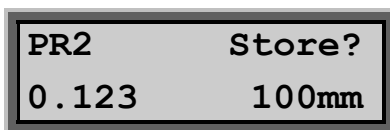

*Display Readings* screen 1

2. Press either **Store** or **Esc**  
(Averaging can be done with or without storing the reading)

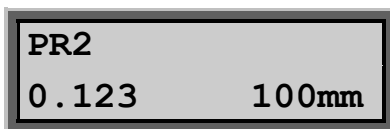

*Display Readings* screen 2

3. Press the **hash #** key once to display the current cumulative average.



*Display Current average* screen.

#? indicates that the latest reading is not yet included.

If no average is currently stored then “No average” is displayed on the bottom line.

4. Press **#** again to update the average with the new reading(s).

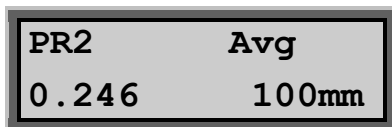

*Display Updated Average*

Alternatively press **[Esc]** to return to the previous display reading screen without updating the average.

Once in the **Display Updated Average** screen, press **Esc** to return to the **Display Reading** screen that you came from. Press **#** to come back to the **Display Updated Average** screen.

Once the average has been updated, press **Read** while in the **Display Updated Average** screen to take a new reading.

(If nothing happens press **Esc**. The question **Store?** may appear, reminding you to decide whether to store the reading. Answer the question by pressing **Store** or **Esc**, then press **Read** and it should work. See items 6 & 7 below)

## What you need to know about averaging

1. Averages are not stored and cannot be uploaded with readings to your PC. Write them down if you want a permanent record.
2. To erase the current cumulative average press **Esc** until you return to the main “Delta-T Devices” menu.
3. After each reading, to store the reading use **Store**. To ignore it press **Esc**. (Neither choice affects the average)
4. To add a displayed reading to the cumulative average press the **#** key twice. Press **#** once to see **Avg# ?** and the previous cumulative average displayed. Press **# again**, the question mark disappears and the average is updated.
5. Averaging works whether or not you store individual readings. The process of selecting readings for inclusion in the cumulative average is completely independent of the process of storing readings for later upload to your PC
6. You may view the average either before or after deciding to store or erase a reading.

7. You will always be asked if you want to store each reading. This applies even if you just want the average.  
**Note:** You cannot take a new reading until you have decided whether or not to store the current one.
8. Your running average will not update if your last reading was outside limits, e.g. an air reading. (It will work OK if you only display readings in mV ).

Note: **Profile Probes:** Be aware that if **any** of the 4 or 6 sensors in your profile probe are outside limits, such as an air reading, **none** of the 4 or 6 sensor readings will be added to the cumulative average.

9. Individual averages are provided for each sensor position in Profile Probes. They are not an average of all the sensors.

## Examples

1. To read, store and average several readings press:  
**Read, Store,#,#.... Read, Store,#,#.... Read, Store,#,#....**
2. To repeatedly read and average but not store readings, press:  
**Read, Esc,#,#.... Read, Esc,#,#.... Read, Esc,#,#....**

Note the cumulative averaging works even if you did not store the reading.

# SM series and ThetaProbe Sensors



## Contents:

- About SM series and ThetaProbes
- Navigation Map
- Quick Start
- Options

---

## About SM series and ThetaProbe Soil Moisture Sensors

These sensors measure volumetric soil moisture content,  $\theta_v$ , by responding to changes in the apparent dielectric constant of moist soil. These changes are converted into a dc voltage in mV, which is then converted to soil moisture content in the HH2 using a linearisation table and soil type parameters.

Volumetric soil moisture content is the ratio between the volume of water present and the total volume of the sample. This is a dimensionless parameter, expressed either as a percentage (%vol), or a ratio ( $\text{m}^3 \cdot \text{m}^{-3}$ ).

If you tell the HH2 the Root-Depth and Field Capacity for a given soil it can also display water deficit in mm (see "Water Deficit Explained" on page 91).



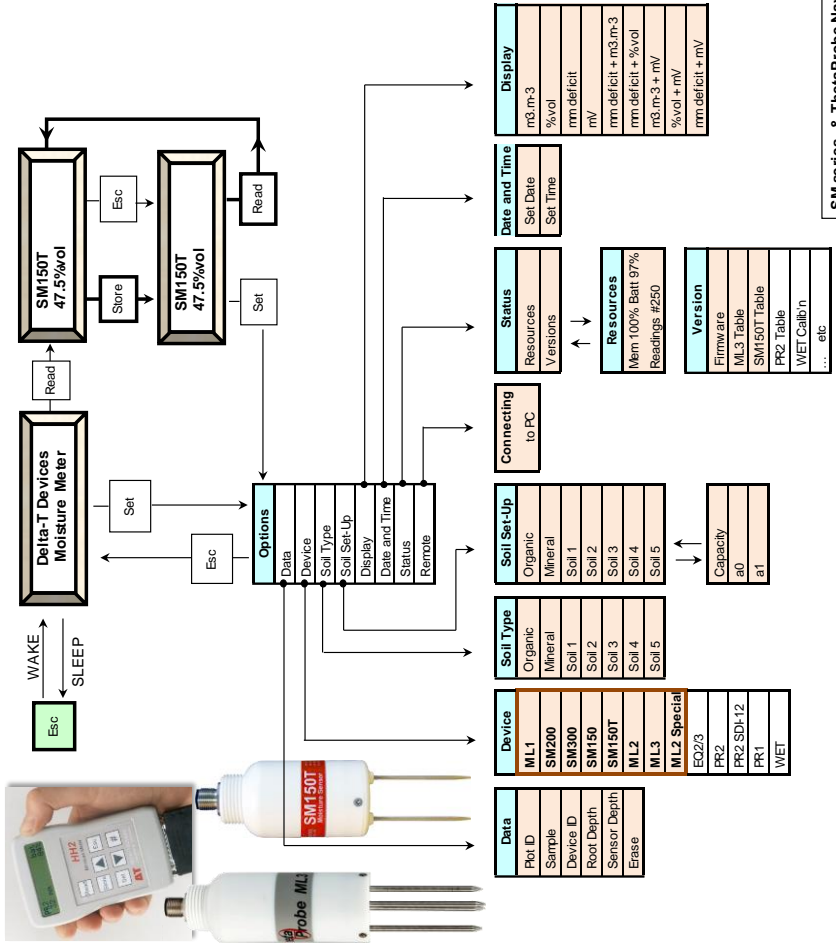
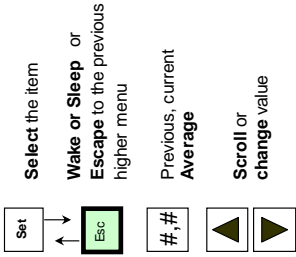

---

# Quick Start

## Before Taking Readings

1. Set the **Device** to SM150T, SM300, ML3 (or another SM.. or ML.. series sensor).
2. Select the **Plot ID**, **Device ID**, **Root Depth** and **Sensor Depth** (all optional).
3. Set the Field **Capacity** (Soil Set-Up menu) if you want soil moisture deficit.
4. Set the **Sample** number (optional, it auto increments).
5. Set the **Display**.
6. Set the **Date and Time** if you have not done so for a few weeks.
7. Connect the HH2 to the sensor.

## To take Readings

1. Press **Read**

If successful the meter displays the reading, e.g.-



2. Scroll to view the other readings (e.g. mm Def).
3. Press **Store** to save the readings, or press **Esc**.
4. Press **Read** for the next reading.

# SM series and ThetaProbe Options

## Summary

Menu	Actions, Notes, (factory default values in <b>bold</b> )
Data	
Plot Id	Sets Plot Label, <b>A..Z</b>
Sample	Sets Sample Number, <b>1..2000</b>
Device Id	Sets Device ID, <b>0..255</b>
Root Depth	Rooting Depth, <b>0..9950mm</b>
Sensor Depth	Sets Sensor Depth, <b>0..9999mm</b>
Erase	<b>No</b> (cancels the action), Yes (erases all readings stored in memory)
Device	Selects the device for subsequent readings. Options are: SM150, SM150T, SM200, SM300, ML1, ML2, <b>ML3</b> , EQ1, EQ2, PR1, PR2, PR2 SDI-12, also EC2 or WET if EC2 or WET calibration is installed
Soil Type	Menu: selects the soil type. Options are: Organic, <b>Mineral</b> or Soil 1...5
Soil Set-Up	Sets the properties of the various soil types.
Organic	Sets Field Capacity for Organic soil, <b>0...38..100 %vol</b>
Mineral	Sets Field Capacity for Mineral soil, <b>0...38..100 %vol</b>
Soil 1..5	
a0	Sets a0 for Soil 1..n, <b>-49.4.. 1.0..50.0</b>
a1	Sets a1 for Soil 1..n, <b>0.1..7.0..50.0</b>
Capacity	Sets Field Capacity for Soil 1..n, <b>0...0.38..1 m<sup>3</sup>.m<sup>-3</sup></b>
Display	Selects the values and units to be displayed and stored Options are: m <sup>3</sup> .m <sup>-3</sup> , <b>%vol</b> , mmDef, mV, mmDef + m <sup>3</sup> .m <sup>-3</sup> , mm def + %vol, m <sup>3</sup> .m <sup>-3</sup> + mV, %vol + mV, mm def + mV
Date and Time	Displays and sets the date and time
Set Date	Date screen
Set Time	Time screen
Status	Displays status information
Resources	Resources screen
Versions	Versions screen
Remote	Connecting to PC screen

## Device

Selects the device to be used for the next reading

Press **Set** at the start-up or readings screen to display the **Options** menu.  
Scroll down to **Device** using the **up**  $\blacktriangle$  and **down**  $\blacktriangledown$  keys and press **Set**.



Scroll down to **SM200**, **ML1** or **ML2** using the up and down keys and press **Set** to select one.



Press **Esc** to return to the start-up screen and press **Read**.

Your chosen device should now appear, and re-appear when the Moisture Meter re-awakes after sleeping.

(Use ML2 for ThetaProbe type ML2x also).

## Data

Select **Options**, **Data** to see this menu.

### Plot ID

You can label each reading with a Plot ID.

Options - A to Z. Default: A.

Select **Options**, **Data**, **Plot ID**.

Scroll through the options, and press **Set** to select one.

Press **Esc** to return to the main menu.

### Sample

A sample number is automatically assigned to each reading.

It automatically increments by one each time you store a reading.

Options: 1 to 2000. Default: 1.

Select **Options**, **Data**, **Sample**.

Select a number and press **Set**.

Press **Esc** to return to the main menu.

### Device ID

You may label readings with a Device ID.

Options: 0 to 255. Default: 0

Select **Options**, **Data**, **Device ID**.

Select a number and press **Set**.

Press **Esc** to return to the main menu.

## Root Depth

This is needed if you want soil moisture deficit (mmDef under Options, Display).

Options 0 .. 9950 mm. Default: 0

Select **Options, Data Root Depth**.

Select a number and press **Set**.

Press **Esc** to return to the main menu.

**WARNING:** Do not use the default settings to take mm Deficit readings. The default Root Depth, set to zero, forces the calculated value for mm Deficit to be zero!

## Sensor Depth

Readings can be labelled with the soil depth.

Options: 0 .. 9950 mm. Default: 0

Select **Options, Data Sensor Depth**.

Select a number and press **Set**.

Press **Esc** to return to the main menu.

## Soil Type

Selects the soil type used in calculating readings.

Options: Mineral, Organic, Soil 1, Soil 2,...Soil 5 Default: Mineral.

Two factory set soil types are installed in the HH2, **Mineral** and **Organic**. You may also define your own via the Soil Set-Up option on the main menu. Up to five custom soil types can be stored in the HH2.

Select **Options, Soil Type** to display the options.

Scroll down through the soil type options and press **Set** to select one.

Press Esc to return to the main menu.

# Soil Set-Up

Soil Set-Up is used to define empirical soil parameters  $a_0$  &  $a_1$ , which are used to convert the measured bulk permittivity into moisture content readings.

Also define the Field Capacity if you want moisture deficit readings.

Beginners can skip this section by choosing one of the defined soli options such as **Mineral** or **Organic** under **Options, Soil Type** and by not choosing mm Deficit under Options, Display.

For optimum accuracy you should obtain soil specific calibration coefficients for your soil as described in your sensor user manual. Then enter these coefficients, called  **$a_0$**  and  **$a_1$** , via the Soil Set-Up menu.

See also: About Soil Parameters  $a_0$  &  $a_1$  on page 67

The fixed values used for the defined soils are :

	$a_0$	$a_1$
Mineral soils	1.6	8.4
Organic soils	1.3	7.7

## Set $a_0$ & $a_1$

These options are available for user-defined soils only

Options :  $a_0$  Range: -49.9 to +50.0 Default: 1.0

$a_1$  Range: 0.1 to 50.0 Default: 7.0

Select Options, **Soil Set-Up**, and select one of Soil 1 through 5.

Select  $a_0$ . Choose an  **$a_0$**  value by scrolling through the range and press **Set** .

Select  **$a_1$**  and repeat the last step.

## Field Capacity

Sets the Field Capacity, used for mm Deficit calculations.

Options: 0 to 1 Default: 0.38 Units:  $m^3.m^{-3}$

If you want **mm Deficit** you must define the **Field Capacity** (and Root Depth in the **Options, Data** menu). We provide a table for Mineral soils on page 94. Organic soils are so variable you have to determine field capacity experimentally, before it makes any sense to take mm Deficit readings - see "Calculating Field Capacity" on page 96.

Press **Set** to select **Options, Soil Set-Up** menu.

Scroll through the Soil names, choose one, pressing **Set**..

Select **Capacity**.

Scroll to select the actual field capacity.

Press **Set** to select it.

---

*Note : A negative "mm Deficit" result indicates you set the Field Capacity too low.*

---

## Display Units Options

Selects the units in which new readings are to be displayed and stored.

Option	Description
m <sup>3</sup> .m <sup>-3</sup>	Volumetric moisture content in cubic metres of water per cubic metre of soil
%Vol	Volumetric water content as a percentage
mm Deficit	Soil moisture deficit in mm.
mV	Sensor output in milliVolts.
mm Deficit + m <sup>3</sup> .m <sup>-3</sup>	Soil moisture deficit in mm Volumetric water content in m <sup>3</sup> .m <sup>-3</sup> .
mm Deficit + %vol	Soil moisture deficit in mm Volumetric water content in m <sup>3</sup> .m <sup>-3</sup> .
m <sup>3</sup> .m <sup>-3</sup> + mV	Volumetric water content in m <sup>3</sup> .m <sup>-3</sup> Sensor output in milliVolts
%Vol + mV	Percentage water content Sensor output in milliVolts.
mm Deficit + mV	Soil moisture deficit in mm Sensor output in milliVolts.

---

**Warning:** Use of the HH2 default value for Field Capacity may not give meaningful results because it may not represent a common soil type.

---

Select the **Options, Display** menu.

Scroll through the following options and press **Set** to select one.

## Date and Time

See Setting the Clock on page 11.

## Status

The Options Status menu displays the Resources and Version sub-menus:

### Resources

Mem: shows % of HH2 memory available for further readings.

Batt: shows remaining battery life.

Readings# : shows number of readings in HH2 memory.

### Version

This shows the version number of the HH2 firmware, i.e. the embedded control program, and also of any installed sensor and soil tables.

## Remote

Select **Options, Remote** to connect to the PC.  
See also PC Software - HH2Read on page 54.

## Memory Full?

The Store option becomes unavailable when memory is full (or corrupted).  
In this case upload the readings to your PC using **HH2Read, Retrieve** then using **Options, Data, Erase** (via the keypad), delete the readings in the HH2.  
See also: Available memory on page 56.

## Upload Data to PC

From the main **Options** menu select **Remote** and press **Set**.  
The rest of the work is done from your PC. If not yet installed, install HH2Read on your PC, as described on page 53.  
Connect the PC to your Moisture Meter as explained on page 54.  
Run HH2Read and select its **Retrieve** command as described on page 59.  
The end result is your data is saved to file in a comma separated (.CSV) format as shown on page 63.

## Then What?

Having got your readings safely stored on your PC, what do you do with the results?  
The .CSV files can be opened in Microsoft Excel for analysis and graphing.  
A Dataset Import Wizard on the DVD or at [www.delta-t.co.uk](http://www.delta-t.co.uk) is provided to **Import** saved data files into Excel in a much more controlled and organised way.  
See page 61.

Further manipulation of the data into irrigation management graphs or reports is beyond the scope of this manual.

Some users send their data to a commercial irrigation management firm for interpretation, or they use a commercial irrigation database management package such as Probe for Windows (see <http://www.rsne.com.au/prwin/pr1.htm>).  
Contact Delta-T for the latest information on compatible irrigation management and graphing solutions.



# Profile Probes



## Contents:

- About Profile Probes
- Menu Navigation Map
- Quick Start
- Options

---

## About Profile Probes

Profile Probe types measure the volumetric soil moisture content at 4 or 6 locations in the soil profile simultaneously.

Soil moisture deficit can be displayed on the HH2 if the Field Capacity and Root Depth are known.

Up to 1800 sets of readings can be stored from a Profile Probe. The actual number depends on which options you choose.

Each sensor in the Profile Probe can be in a different soil horizon

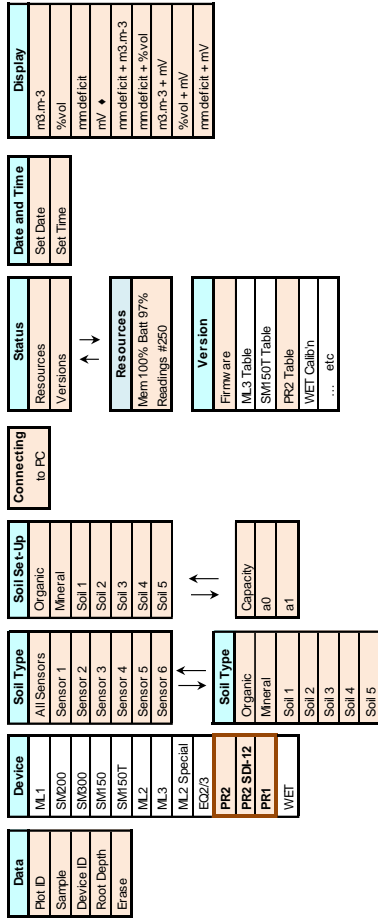
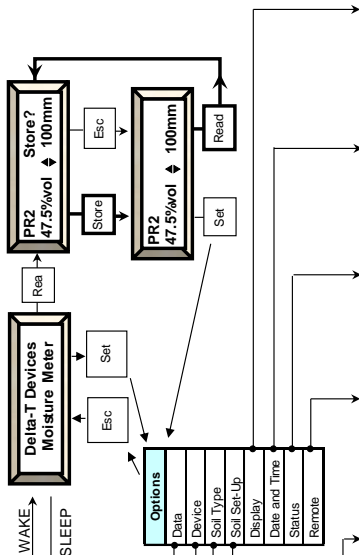
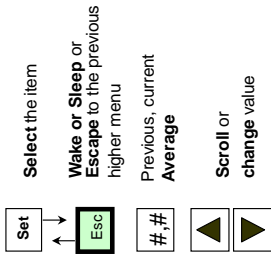

♦ not available from SDJ-12, PR2

PR2 Navigation Map - v7 11/11/2016

---

# Reading the Profile Probe

## Before Taking Readings

Check the following.

1. Set the Device type to PR1, PR2 or PR2 SDI-12. This needs to be done whenever you change the type of device.
2. Set Soil Type for every sensor in the Profile Probe.
3. If you have not selected one of the standard soil types then define your soil parameters using the Soil Set-Up menu.
4. Set the Root Depth and Field Capacity if you want mm Deficit.
5. Set the Clock if you have not done so for a few weeks.
6. Select the Plot and Device IDs (optional).
7. Set the Sample number (optional, it auto increments).
8. Connect the HH2 to the Profile Probe.

## To take Readings

1. Press **Read**.

If successful the meter displays the reading, for example:



Volumetric soil moisture 100mm below surface.

The meter displays the reading from the first sensor, nearest the surface, at 100 mm.

2. Press **▲** or **▼** to scroll the display for other sensor depths and secondary units (if selected in Options, Display). The distance displayed is the sensor depth from the surface.

3. Press **Store** to save the reading.

Press **Esc** if you do not want to save the reading.

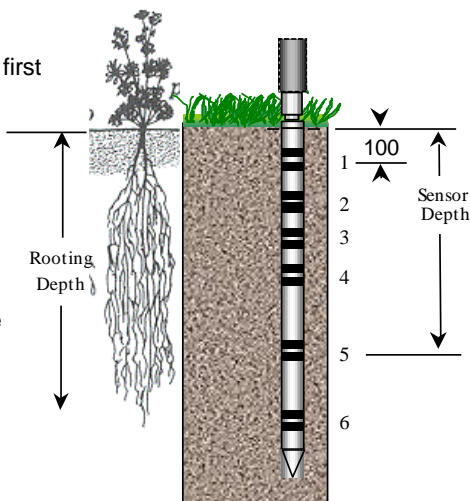

# Profile Probe Options

## Summary

7Menu	Actions, Notes(factory default values in <b>bold</b> )
Data	
Plot Id	Sets Plot Label, <b>A..Z</b>
Sample	Sets Sample Number, <b>1..2000</b>
Device Id	Sets Device ID, <b>0..255</b>
Root Depth	Sets Rooting Depth, <b>0..9950mm</b>
Erase	<b>No</b> (cancels the action), Yes (erases all readings stored in memory)
Device	Selects the device for subsequent readings. Options are: SM150, SM150T, SM200, SM300, ML1, ML2, EQ1, EQ2, , <b>PR1, PR2, PR2 SDI-12</b> and WET if WET calibration is installed
Soil Type	Selects the soil types for each of the 4 or 6 sensors in the Profile Probe.
All Sensors	Selects the same soil type for all sensors in the probe. Options : Organic, Soil 1..5
Sensors 1..6	Selects a separate soil type for each sensor. Options : Organic, <b>Mineral</b> , or Soil 1..5
Soil Set-Up	Sets the properties of the various soil types.
Organic	Sets Field Capacity for Organic soil, <b>0..38..100%</b>
Mineral	Sets Field Capacity for Mineral soil, <b>0..38..100%</b>
Soil 1..5	
a0	Sets a0 for Soil 1..n, <b>-49.9 1.0 50.0</b>
a1	Sets a1 for Soil 1..n, <b>0.1 7.0 50.0</b>
Capacity	Sets Field Capacity for Soil 1..n, <b>0..0.38..1 m<sup>3</sup>.m<sup>-3</sup></b>
Display	Selects the values and units to be displayed and stored. Options are: m <sup>3</sup> .m <sup>-3</sup> , <b>%vol</b> , mmDef, mV*, mmDef + m <sup>3</sup> .m <sup>-3</sup> , mm def + %vol, m <sup>3</sup> .m <sup>-3</sup> + mV*, %vol + mV*, mm def + mV* (*Note mV values are <b>not available</b> from the SDI-12 PR2)
Date and Time	Displays and sets the date and time
Set Date	Date screen
Set Time	Time screen
Status	Displays status information
Resources	Resources screen
Versions	Versions screen
Remote	Connecting to PC screen

# Device

Press **Set** at the start-up or readings screen to display the **Options** menu. Scroll down to **Device** using the **up**  $\blacktriangle$  and **down**  $\blacktriangledown$  keys and press **Set**.



Scroll down to PR2, PR1 or PR-Special and press **Set** -



Press **Esc** to return to the start-up screen

This sensor should now appear on the start-up screen, and re-appear at start-up if you turn the power off.

# Data

Select **Options, Data** to see this menu.

## Plot ID

You can label each reading with a Plot ID.

Options - A to Z. Default: A.

Select **Options, Data, Plot ID**.

Scroll through the options, and press **Set** to select one.

Press **Esc** to return to the main menu.

## Sample

A sample number is automatically assigned to each reading.

It automatically increments by one each time you store a reading.

Options: 1 to 2000. Default: 1.

Select **Options, Data, Sample**.

Select a number and press **Set**.

Press **Esc** to return to the main menu.

## Device ID

You may label readings with a Device ID.

Options: 0 to 255. Default: 0

Select **Options, Data, Device ID**.

Select a number and press **Set**.

Press **Esc** to return to the main menu.

## Root Depth

This is needed if you want soil moisture deficit (mmDef under Options, Display).

Options: 0 .. 9950 mm. Default: 0

Select **Options, Data Root Depth**.

Select a number and press **Set**.

Press **Esc** to return to the main menu.

**WARNING:** Do not use the default settings to take mm Deficit readings. The default Root Depth, set to zero, forces the calculated value for mm Deficit to be zero!

Some irrigation consultants recommend 700 mm as a suitable standard value for Root Depth.

## Soil Type (first menu)

Displays a choice of sensors for associating with a soil type in the next sub-menu.

Options : All Sensors, Sensor 1, Sensor 2,.....Sensor 6 Default: All Sensors

Each sensor in a Profile Probe can have a different soil type associated with it. You may choose to set all sensors to the same soil, or individually set each one.

Select **Options, Soil Type** and select a particular sensor or All Sensors, to open the second level Soil Type menu.

Note: Sensor 1 denotes the first sensor nearest the surface, usually at 100 mm. Sensor 4 is at 400 mm.

In a PR2/6 the lowest sensor is Sensor 6 at 1000 mm.

## Soil Type (sub-menu)

Displays a choice of soil types to associate with the previously selected sensor(s).

Options: Organic, Mineral, Soil 1, Soil 2.....Soil 5. Default: Mineral

Two soil types are always available, **Mineral** and **Organic**.

You may also define five more via **Soil Set-Up** on the **Options** menu.

Having selected a sensor or all sensors under Options, Soil Type, now select a soil.

### Example: To set all sensors to Organic

Select Options, Soil Type, All Sensors, Organic

This will set all sensors in the Profile Probe to use the default Organic soil parameters a0 and a1.

## Soil Set-Up (first menu)

Displays a choice of soil types for defining soil parameters.

Options: Organic, Mineral, Soil 1, Soil 2.....Soil 5. Default: Mineral

Soil Set-Up is used to define empirical soil parameters a0 & a1 used to convert the measured bulk permittivity into moisture content readings.

Soil Set-Up is also used to define field water capacity, needed if you want moisture deficit readings.

Beginners can skip this section by choosing the Mineral or Organic under Options , Soil Type and by not asking for mm Deficit in the Options, Display menu.

See also: About Soil Parameters a0 & a1 on page 67

## Soil Set-Up (sub-menu)

Displays available soil parameters that may be defined.

### a0 & a1

These options are available for user-defined soils only, not Mineral or Organic

Options: a0 Range: -49.9 to +50.0 Default: 1.0

a1 Range: 0.1 to 50.0 Default: 7.0

Previously you should have selected a custom soil name from the **Options, Soil Set-Up** menu.

Select **a0**. Choose an **a0** value by scrolling through the range and press **Set** .  
Select **a1** and repeat the last step.

### Field Capacity

Sets the Field Capacity, used for mm Deficit calculations.

Options: 0 to 1 Default: 0.38 Units: m<sup>3</sup>.m<sup>-3</sup>

If you want **mm Deficit** you must define the **Field Capacity** (and Root Depth in the **Options, Data** menu).

See the table for Mineral soils on page 94.

Organic soils are so variable you have to determine field capacity experimentally, before it makes any sense to take mm Deficit readings.

See "Calculating Field Capacity" on page 96.

Select **Options, Soil Set-Up** and choose a soil.

Select **Capacity**.

Scroll to select the actual field capacity.

Press **Set** to select it.

---

*Note : A negative "mm Deficit" result indicates that you set the Field Capacity too low.*

---

## Display

This menu lists the units in which new readings may be displayed and stored.

Only one option may be selected per Profile Probe.

Select **Options**, **Display** scroll through the options and press **Set** to select one.

Option	Description
m <sup>3</sup> .m <sup>-3</sup>	Volumetric moisture content in cubic metres of water per cubic meter of soil
%Vol	Volumetric water content as a percentage
mm Deficit	Soil moisture deficit in mm
mV	Sensor output in millivolts <i>(not available on the PR2 SDI-12)</i>
mm Deficit + m <sup>3</sup> .m <sup>-3</sup>	Soil moisture deficit in mm Volumetric water content in m <sup>3</sup> .m <sup>-3</sup>
mm Deficit + %vol	Soil moisture deficit in mm Volumetric water content in m <sup>3</sup> .m <sup>-3</sup>
m <sup>3</sup> .m <sup>-3</sup> + mV	Volumetric water content in m <sup>3</sup> .m <sup>-3</sup> Sensor output in millivolts
%Vol + mV	Percentage water content Sensor output in millivolts
mm Deficit + mV	Soil moisture deficit in mm Sensor output in millivolts

---

**Warning:** Use of the HH2 default value for Field Capacity may not give meaningful results because it may not represent a common soil type.

You must also enter a Root Depth or the result will be zero.

---

## Set the Clock

See Setting the Clock on page 11.

## Status

The **Options**, **Status** menu displays Resources and Version sub-menus.

### Resources

Mem: shows % of HH2 memory available for further readings.

Batt: shows remaining battery life.

Readings# : shows number of readings in HH2 memory.

### Version

This shows the version number of the HH2 firmware, i.e. the embedded control program, and also of any installed sensor and soil tables.



## Remote

Select **Options, Remote** to connect to the PC.  
See also : Connect PC to HH2 on page 54.

## Memory Full?

The Store option becomes unavailable when memory is full (or corrupted). In this case upload the readings to your PC using HH2Read **Retrieve**, then, using **Options, Data, Erase** (via the keypad), delete the readings in the HH2.

**See also** : Memory use on page 51.

## Upload Data to PC

From the main **Options** menu select **Remote** and press **Set**.

The rest of the work is done from your PC keyboard. If not yet installed, install HH2Read on your PC as described on page 53.

Connect the PC to your Moisture Meter as explained on page 54.

Run HH2Read and select its **Retrieve** command as described on page 59.

The end result is your data is saved to file in a comma separated (.CSV) format as shown on page 63.

## Then What?

Having got your readings safely stored on your PC, what do you do with the results?

The .CSV files can be loaded directly into spreadsheet packages like Microsoft Excel for analysis and graphing.

The Dataset Import Wizard provided with HH2Read enables you to import this .CSV file into Excel in a much more controlled and organised way.

See page Dataset Import Wizard on page 61

Further manipulation of the data into irrigation management graphs or reports is beyond the scope of this manual.

Some users send their data to a commercial irrigation management firm for interpretation, or they use a commercial irrigation database management package such as Probe for Windows (see <http://www.rsne.com.au/prwin/pr1.htm>). Contact Delta-T for the latest information on compatible irrigation management and graphing software.



# WET Sensor



## Contents:

- About WET Sensors
- Menu Navigation Map
- Options

---

## About WET Sensors

The WET sensor's name comes from Water content, Electrical conductivity and Temperature.

WET sensors directly measure soil permittivity  $\epsilon$ , bulk electrical conductivity (denoted  $\sigma_b$  or  $EC_b$ ) and Temperature. From these, and with the use of specific soil calibration tables and equations, the HH2 calculates volumetric soil moisture  $\theta$ , and pore water conductivity  $\sigma_p$  or  $EC_p$ .

The WET sensor is used in precision horticulture and soil science research and is usable in both soils and a variety of artificial growing substrates, such as rock wool. It is unique in its ability to measure pore water conductivity - which is the conductivity directly available to the plant (indicating, for instance, the availability of nutrients in solution).

See also the WET user manual.

The standard HH2 includes WET sensor soil parameters for organic, mineral, clay and sand. Additional artificial soil substrates such as coir, stone-wool & peat may be installed in the HH2, but this has to be done at Delta-T.

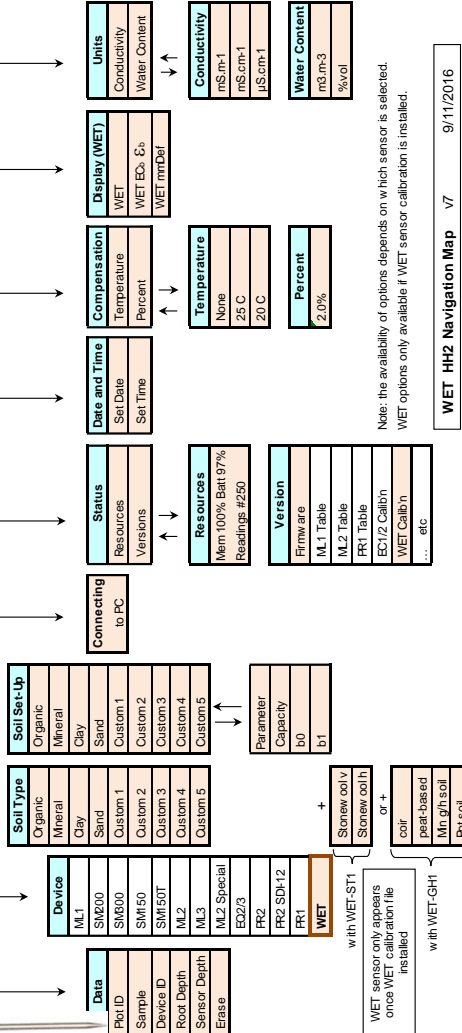
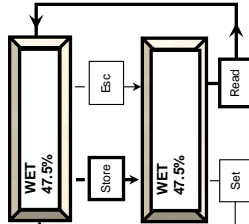
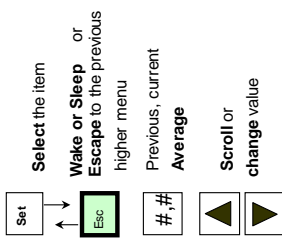

Note: the availability of options depends on which sensor is selected. WET options only available if WET sensor calibration is installed.

---

## Install WET Sensor Calibration

A calibration file is provided on DVD with each WET Sensor. Alternatively download it at [www.delta-t.co.uk](http://www.delta-t.co.uk)

- 1) Identify your sensor serial number. This can be found on the blue rubber sleeve attached to your WET sensor cable.

Example:

If serial number is                    WET-1/020  
then calibration file name is   WET01020.cal.

- 2) Connect the HH2 to your PC using the serial cable.
- 3) Run the PC program **HH2Read**. (You need version 1.82 or later.)
- 4) Select **Install, Sensors Calibration, WET Sensor**.
- 5) Insert the DVD containing the calibration file, select it via the Open dialogue and press Return.

In a few seconds the program should report the calibration file successfully installed.

---

## Reading the WET Sensor

### Before Taking Readings

Check the following.

1. Install your WET sensor calibration table in the HH2 using HH2Read.
2. Set the **Device** type to WET.
3. Select the **Plot ID, Device ID, Root Depth** and **Sensor Depth** (all optional).
4. Set the Field **Capacity** (Soil Set-Up menu) if you want soil moisture deficit.
5. Set the **Sample** number (optional, it auto increments).
6. Set the **Display** and **Units**.
7. Set the type of temperature **Compensation** you want, if any.
8. Set the **Date and Time** if you have not done so for a few weeks.
9. Connect the HH2 to the sensor.

## To take Readings

1. Press **Read** on the HH2 keypad.

If successful the meter displays the reading, e.g.

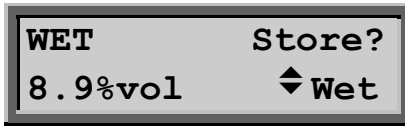

2. Scroll to view the other readings.
3. Press **Store** to save the readings, or press **Esc**.
4. Press **Read** for the next reading.

## Memory Full?

The Store option becomes unavailable when memory is full (or corrupted). In this case upload the readings to your PC using HH2Read, **Retrieve**, then, using **Options, Data, Erase** (via the keypad), delete the readings in the HH2.

# WET Options Summary

Menu	Actions, Notes, (factory default values in <b>bold</b> )
Data	
Plot Id	Sets Plot Label, <b>A..Z</b>
Sample	Sets Sample Number, <b>1..2000</b>
Device Id	Sets Device ID, <b>0..255</b>
Root Depth	Sets Rooting Depth, <b>0..9950mm</b>
Sensor Depth	Sets Sensor Depth, <b>0..9999mm</b>
Erase	<b>No</b> (cancels the action), Yes (erases all stored readings)
Device	Selects the device for subsequent readings. Options : SM150, SM150T, SM200, SM300, ML1, ML2, ML3, EQ1, EQ2, PR1, PR2, PR2 SDI-12; also WET if WET calibration is installed
Soil Type	Selects the soil type for WET sensor readings. Options: Organic, Mineral, Clay, Sand, Custom 1..5; also Stonewool v & Stonewool h (WET-ST-1 option) also Coir, Peat-based, Min g/h soil & Pot soil (WET-GH-1)
Soil Set-Up	Sets the properties of the various WET soil types.
Custom 1..n, Organic, Mineral, Custom 1..n	
b0	(Custom 1..n only) Sets b0 for Custom 1..n, <b>1.0..2.0</b>
b1	(Custom 1..n only) Sets b1 for Custom 1..n, <b>7.0..8.5</b>
Parameter	Sets Soil Parameter, 1.0.. <b>4.1</b> ..9.0
Capacity	Sets Field Capacity, 0.. <b>0.38</b> ..1 m <sup>3</sup> .m <sup>-3</sup>
Units	Selects the units for displaying and storing WET readings.
Conductivity	Selects the Conductivity units. Options : <b>mS.m<sup>-1</sup></b> , mS.cm <sup>-1</sup> , μS.cm <sup>-1</sup>
Water Content	Selects the Wetness units. Options : m <sup>3</sup> .m <sup>-3</sup> , <b>%vol</b>
Display	Selects the values to be displayed and stored for WET readings. Options : <b>WET</b> , WET EC <sub>b</sub> ε <sub>b</sub> , WET mmDef
Compensation	
Temperature	Sets the temperature to which conductivity readings are adjusted. Options : <b>None</b> , 20°C, 25°C
Percent	Sets the % temperature compensation, -1.0.. <b>2.0</b> ..4.0%
Date and Time	Displays and sets the date and time
Set Date	Date screen
Set Time	Time screen
Status	Displays status information
Resources	Resources screen
Versions	Versions screen
Remote	Connecting to PC screen

# Device

Press **Set** at the start-up or readings screen to display the **Options** menu. Scroll down to **Device** using the **up** ▲ and **down** ▼ keys and press **Set**.



Scroll down to **WET** and press **Set** -



Press **Esc** to return to the start-up screen

This sensor should now appear on the start-up screen, and re-appear at start-up if you turn the power off.

# Data Menu

Select **Options, Data** to see this menu.

## Plot ID

You can label each reading with a Plot ID.

Options: - A to Z. Default: A.

Select **Options, Data, Plot ID**.

Scroll through the options, and press **Set** to select one.

Press **Esc** to return to the main menu.

## Sample

A sample number is automatically assigned to each reading.

It automatically increments by one each time you store a reading.

Options: 1 to 2000. Default : 1.

Select **Options, Data, Sample**.

Select a number and press **Set**.

Press **Esc** to return to the main menu.

## Device ID

You may label readings with a Device ID.

Options: 0 to 255. Default: 0

Select **Options, Data, Device ID**.

Select a number and press **Set**.

Press **Esc** to return to the main menu.



## Root Depth

This is needed if you want soil moisture deficit ( mmDef under Options, Display).

Options: 0 .. 9950 mm. Default : 0

Select **Options, Data Root Depth**.

Select a number and press **Set**.

Press **Esc** to return to the main menu.

## Sensor Depth

Readings can be labelled with the soil depth.

Options: 0 .. 9950 mm. Default : 0

Select **Options, Data Sensor Depth**.

Select a number and press **Set**.

Press **Esc** to return to the main menu.

## Soil Type

WET sensors require a soil type to be selected, because the soil moisture calculation uses a soil-specific calibration table.

Tables for the standard soils listed below are pre- installed in the HH2.

You can install 5 custom tables using your own soil calibration data if you have any.

Support for special horticultural soils may be purchased. To install these you need to return your HH2 to Delta-T. Please contact us first for shipping instructions.

Options: **Standard soil calibrations - Mineral, Organic, Clay, Sand.**

**Custom soil calibration - Custom 1, Custom 2, Custom 3, Custom 4, Custom 5.**

**WET-ST-1 table – stone wool horizontal, stone wool vertical (See WET User Manual).**

**WET-GH1 table – Coir-base, Peat based, Mineral or Pot soils (See WET User Manual).**

Select **Options, Soil Type**

Select a soil and press **Set**.

## Soil Set-Up

### b0 and b1

These can only be changed for Custom Soils installed by the user.

Refer to your WET User manual for the significance of these settings

Options: b0 1.0...2.0 Default : 1.0

b1 1.0...8.5 Default : 7.0

Select **Options, Soil Set-Up, b0**

Select a soil and press **Set**.

## Parameter

The soil parameter represents the soil permittivity for which the bulk conductivity is zero. It is non zero because dry soils are polarisable.  
Refer to your WET User manual for more information.

Options: 1.0...9.0 Default : 4.1

Select **Options, Soil Set-Up, Parameter**

Select a value and press **Set**.

## Field Capacity

A value for the Field Capacity must be set if you want to display soil moisture deficit.

See also: "Water Deficit Explained" on page 91.

"Field Water Capacity Values" on page 94.

Options: 0...1 Default: 0.38 m<sup>3</sup>.m<sup>-3</sup>

Select **Options, Soil Set-Up, Capacity**

Select a value and press **Set**.

## Units

Conductivity and water content readings can be displayed in a range of units.

### Conductivity

Options: mS.m<sup>-1</sup>, mS.cm<sup>-1</sup>, μS.cm<sup>-1</sup>

Select **Options, Units, Conductivity**.

Scroll to your option and press **Set**.

### Water Content

Options : m<sup>3</sup>.m<sup>-3</sup>, %vol.

Select **Options, Units, Water Content**

Scroll to your option and press **Set**.

## Display

Use this menu to select the different physical quantities which are to be recorded each time you press read.

Options:

**WET** i.e. Water content, pore Electrical conductivity and Temperature  
or

**WET EC<sub>b</sub> ε<sub>b</sub>** i.e. Water content, pore Electrical conductivity and Temperature  
plus bulk electrical conductivity and bulk permittivity.

or

**WET mmDef** i.e. Water content, pore Electrical conductivity and Temperature  
plus soil moisture deficit.

# Compensation

Readings of electrical conductivity can be temperature compensated if required. For some applications it is useful to know the true electrical conductivity at the measurement temperature. In that case uncompensated readings are required, and this is the default for the HH2.

For most applications the electrical conductivity is a means of estimating the ionic content of the pore water, and for these applications it is necessary to compare readings after they have been adjusted to a standard temperature.

Unfortunately this isn't straightforward because:

- 20°C and 25°C are both used as standards,
- The temperature compensation percentage depends on the particular mixture of ions present in the pore water. For example:

<i>ion</i>	<i>temperature sensitivity of EC*</i>
<i>Na<sup>+</sup></i>	2.1
<i>K<sup>+</sup></i>	1.9
<i>½ Ca<sup>++</sup></i>	2.1
<i>H<sup>+</sup></i>	1.5
<i>NH<sub>4</sub><sup>+</sup></i>	1.9
<i>Cl<sup>-</sup></i>	1.9
<i>NO<sub>3</sub><sup>-</sup></i>	1.8
<i>OH<sup>-</sup></i>	1.5
<i>P<sub>2</sub>O<sub>5</sub><sup>-</sup></i>	not known

\* The values quoted are approximate for 25°C.

The choice of standard temperature and compensation % will depend on what is commonly used for comparison purposes within your application.

## Temperature

Options: None, 25 °C, 20 °C    Default: None.

Select **Options, Compensation, Temperature**.

Scroll and press **Set** to select one.

Press **Esc** to return to the main menu.

## Percent

Options: -1.0 to 4.0%    Default: 2.0%

Select **Options, Compensation, Percent**.

Scroll and press **Set** to select one.

Press **Esc** to return to the main menu.

# Date and Time

See Setting the Clock on page 11.

# Status

The **Options, Status** menu displays the Resources and Versions sub-menus.

## Resources

Mem: shows % of HH2 memory available for further readings.

Batt: shows remaining battery life.

Readings# : shows number of readings in HH2 memory.

## Version

This shows the version number of the HH2 firmware, i.e. the embedded control program, and also of any installed sensor and soil tables.

# Remote

Select **Options, Remote** to connect to the PC.

See also:

# Upload Data to PC

From the main **Options** menu select **Remote** and press **Set**.

The rest of the work is done from your PC. If not yet installed, install HH2Read on your PC as described on page 53.

Connect the PC to your Moisture Meter as explained on page 54.

Run HH2Read and select its **Retrieve** command as described on page 59.

The end result is your data is saved to file in a comma separated (.CSV) format as shown on page 63.

# Then What?

Having got your readings safely stored on your PC, what do you do with the results?

The .CSV files can be **Opened** in Microsoft Excel for analysis and graphing.

A Dataset Import Wizard is provided with HH2 Read to help you **Import** data files into Excel in a much more controlled and organised way.

For more on the Dataset Import Wizard see page 61.

Further manipulation of the data into irrigation management graphs or reports is beyond the scope of this manual.

Some users send their data to a commercial irrigation management firm for interpretation, or they use a commercial irrigation database management package such as Probe for Windows (see <http://www.rsne.com.au/prwin/pr1.htm>).

Contact Delta-T for the latest information on compatible irrigation management and graphing solutions.

# Equitensiometers



---

## About Equitensiometers

Equitensiometer type EQ3 measures the negative pressure (or suction) required to extract water from between the matrix of soil particles. This is an important indication of plant water stress. See also the Glossary.

Equitensiometer readings are normally given in kPa, but the HH2 only displays the output in mV. Once readings are uploaded to your PC you may derive the soil matrix potential (in kPa) using the unique linearisation table supplied with each sensor, as described in its User Manual.

When the Moisture Meter wants a reading it applies an excitation voltage for as long as it is needed. The excitation voltage, taken from the meter's internal battery, stimulates the Equitensiometer into taking a reading and producing an output signal in mV.

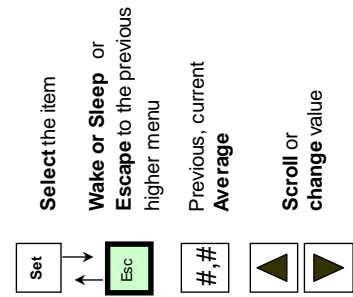

Select the item

Wake or Sleep or  
Escape to the previous  
higher menu

Previous, current  
Average

Scroll or  
change value

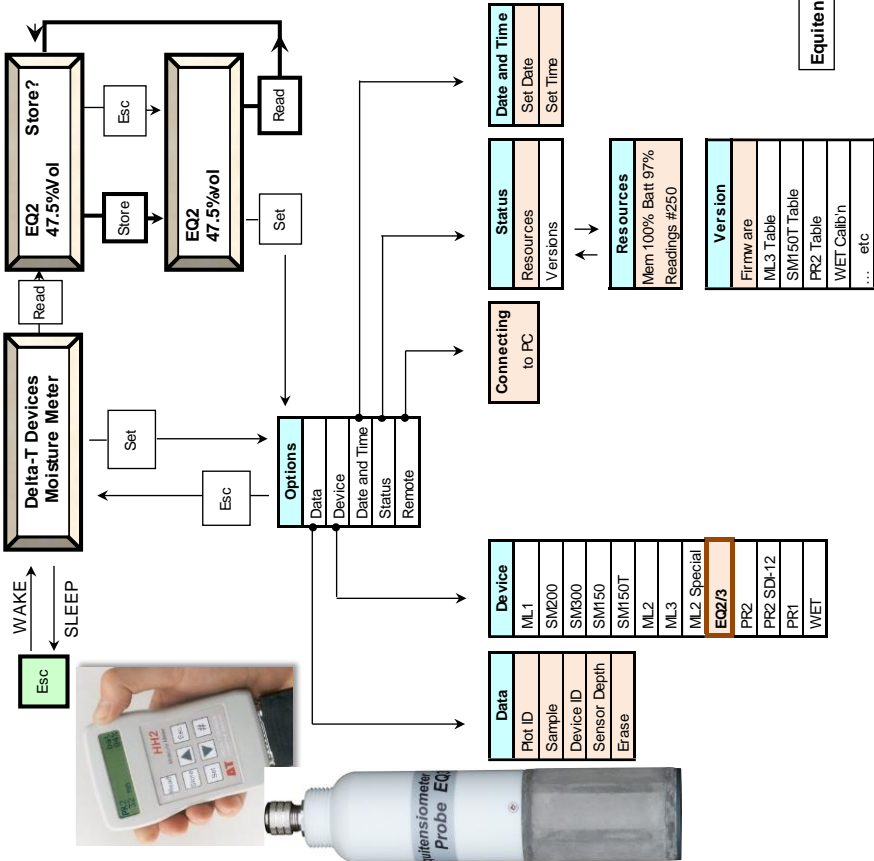

Equitensiometer Navigation Map 1/12/2016

---

# Reading the Equitensiometer

## Before taking readings

1. Select **Options, Device, EQ2**

2. Connect it to the HH2.

See also: Accessories on page 90

3. Set the Plot, Sample and Device ID's and Sensor Depth if you wish.

See also: Equitensiometer Options on page 48.

## To take Readings

1. Press **Read** on the HH2 keypad.

If successful the meter displays the reading, e.g.



*Reading ready for saving or deleting*

2. Press **Store** to save the readings, or press **Esc**.

3. Press **Read** for the next reading

Press **Esc** if you do not want to save the reading. It will still show on the display but has not been saved.

## Can't Store Readings?

The Store option becomes unavailable when memory is full (or corrupted). In this case upload the readings to your PC using HH2Read, then, using **Options, Data, Erase** (via the keypad), delete the readings in the HH2.

See also: Available memory on page 56.

---

# Equitensiometer Options

## Summary

Main Menu	Sub Menu	Values	Default (Factory)
Data	Plot ID	A..Z	last (A)
	Sample	1..2000	last (1)
	Device ID	0..255	last (0)
	Sensor Depth	0..9950 mm	last (0)
	Erase	Yes/No	No (not applicable)
Device	ML1	-	ML2
	SM200		
	ML2	-	-
	PR1 - Direct	-	-
	PR1 - Access	-	-
	PR1-SP-Direct	-	-
	PR1-SP-Access	-	-
	EQ2	-	-
Date and Time	Set Date	dd/mm/yy *	01/01/2000
	Set Time	hh:mm:ss	00:00:00
Status	-	-	-
Remote	-	-	-

### Notes

\* Date order format is automatically set by your PC when you set the time using the data collection software HH2Read.

**The HH2 reverts to the default values if power is lost for more than 30 seconds.**

## Device

Selects the device to be used for the next reading.

Press **Set** at the start-up or readings screen to display the main **Options** menu. Using the **up** ▲ and **down** ▼ keys, scroll down to **Device** and press **Set**.





Scroll down to **EQ2** using the up and down keys and press **Set**.

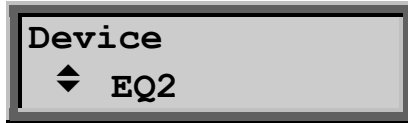

Press **Esc** to return to the start-up screen or last reading.

The selected EQ2 should now appear on the start-up screen, and re-appear at start-up when the HH2 awakes after sleeping.

## Data Menu

Select **Options, Data** to see this menu.

### Plot ID

You can label each reading with a Plot ID.

Options: - A to Z. Default: A.

Select **Options, Data, Plot ID**.

Scroll through the options, and press **Set** to select one.

Press **Esc** to return to the main menu.

### Sample

A sample number is automatically assigned to each reading.

It automatically increments by one each time you store a reading.

Options: 1 to 2000. Default: 1.

Select **Options, Data, Sample**.

Select a number and press **Set**.

Press **Esc** to return to the main menu.

### Device ID

You may label readings with a Device ID.

Options: 0 to 255. Default: 0

Select **Options, Data, Device ID**.

Select a number and press **Set**.

Press **Esc** to return to the main menu.

### Sensor Depth

Readings can be labelled with the soil depth.

Options: 0 .. 9950 mm. Default : 0

Select **Options, Data Sensor Depth**.

Select a number and press **Set**.

Press **Esc** to return to the main menu.

## Date and Time

See Setting the Clock on page 11.

## Status

The **Options, Status** menu displays the Resources and Version sub-menus:

### Resources

Mem: shows % of HH2 memory available for further readings.

Batt: shows remaining battery life.

Readings # : shows number of readings in HH2 memory.

### Version

This shows the version number of the HH2 firmware, i.e. the embedded control program, and also of any installed sensor and soil tables.

## Remote

Select **Options, Remote** to connect to the PC.

See also:

## Upload Data to PC

From the main **Options** menu select **Remote** and press **Set**.

The rest of the work is done from your PC. If not yet installed, install HH2Read on your PC, as described on page 53.

Connect the PC to your Moisture Meter as explained on page 54.

Run HH2Read and select its **Retrieve** command as described on page 59.

The end result is that your data is saved to file in a comma separated (.CSV) format as shown on page 63.

## Then What?

Having got your readings safely stored on your PC, what do you do with the results?

The .CSV files can be opened by Microsoft Excel for analysis and graphing.

A Dataset Import Wizard is provided with HH2Read to help you import data files into Excel in a much more controlled and organised way.

For more on the Dataset Import Wizard see page 61.

Further manipulation of the data into irrigation management graphs or reports is beyond the scope of this manual.

Some users send their data to a commercial irrigation management firm for interpretation, or they use a commercial irrigation database management package.

Contact Delta-T for the latest information on compatible irrigation management and graphing solutions.

# Memory use

---

## Stored readings

To see the number of readings taken and memory used, select **Options, Status, Resources**.

The number of readings you can save depends on what device and what menu options you select and how often you change them.

## How Many Readings Can I Take?

The number of readings depends on how much information you change each time you take a reading, on which device you are using, and on how many different reading units you elect to display and save.

For maximum and minimum numbers of readings for various configuration changes and sensors see "Maximum Number of Readings" on page 76.

## Optimising Memory

More readings can be saved if you if you only select one, not two, sets of engineering units under **Options, Display**.

You may change Sample, in the **Option, Data** for each reading without affecting the total number of readings. (The Sample number automatically increases by one otherwise anyway).

To get the most readings try to group all your options together.

Do not worry too much about memory use, the actual memory overhead of changing a single option is quite small, typically 0.06%.

No additional penalty is incurred if you change your mind before pressing the Store button. Changing a configuration only affects memory when a reading is stored. If you change the configuration for soil 10 times but only store the reading after those 10 changes, only the last change is stored so memory is only used once.

When you change any option **other** than the Data options -Device ID, Plot ID or Sample, then extra lines are inserted in the data record saved to the PC. Next time you press Store, the row by row sequence of readings eventually sent to your PC is disrupted by the insertion of 9 rows of header information summarising all the options (plus 2 blank rows) . This can be seen in the example output file shown on page 65 in which the units (Display option) were changed after the fourth reading. If you do this too often it could make life more complicated later when you come to interpret the data. It also consumes memory.

---

## How do I erase readings?

The readings stored in the HH2 should be erased once you have successfully uploaded them to your PC.

The data is erased via the keypad, not from the PC.

Select **Options, Data, Erase**.

The default setting is **No**. Scroll up for **Yes** and press **Set**.

To inspect the results of your action select **Options, Resources, Status**. This will display the amount of memory used and the number of sets of readings in memory.

---

## What happens when the meter runs out of memory?

Once memory is full you can take readings but you cannot save them. A message is displayed saying "memory full".

To save further readings you should first upload the stored readings to your PC using the PC program HH2Read, Retrieve.

Then erase the readings in the HH2 - see above.

# PC Software - HH2Read

---

## Introduction

Use HH2Read v 2.8 or later to collect data from your HH2 Moisture Meter. Readings are saved to a file on your PC, in a comma separated format. This can be viewed and graphed by loading it into Excel or similar spreadsheet packages.

HH2Read can also do the following:

- Set the time of the HH2 Moisture Meter.
- Display memory and battery status.
- Display the status of the linearisation tables.
- Send linearisation tables to the meter.

---

## Installation

HH2Read runs on Windows 95 through to Windows 10

To install the software on your PC:

1. Insert the distribution disk in your DVD drive or download HH2Read from <http://www.delta-t.co.uk/product/hh2/#support>.
2. Click on HH2Read.exe to run the setup program and follow the on-screen instructions

The software will install onto your PC, placing an entry for this application in your Programs menu.

You can now install an Excel add-in called Dataset Import Wizard, see page 61.

---

**Note:** *if you have problems installing your software, then make a note of exactly what happened and record all error messages which are reported. See the Technical Support section at the rear of this manual for details of how to obtain help with installation problems.*

---

---

# Connect PC to HH2

Attach the 25 to 9 way adapter to the HH2 Moisture Meter.

Plug the RS232 cable into this adapter and into a serial port on your PC.  
(If your PC does not have a COM port with a 9-way D connector, purchase a USB-RS232 adapter and install it on your PC).

Select **Remote** from the HH2 Options menu. The HH2 should display "Connecting to PC"

Run HH2Read on your PC.

The applications main window should appear, as follows

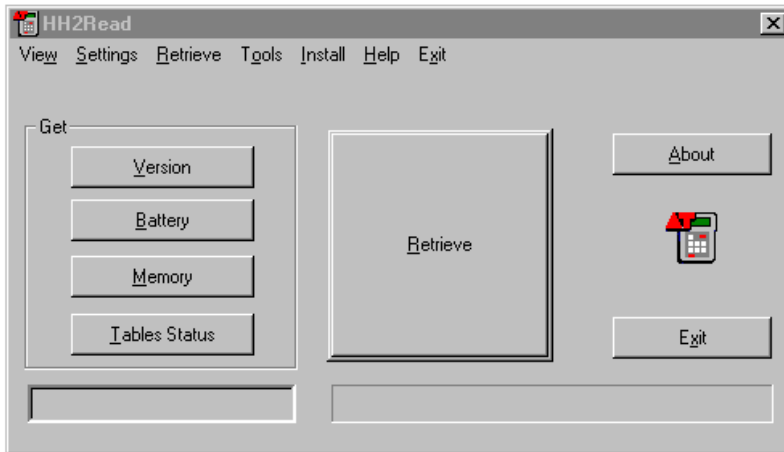

The software has 6 menus at the top of the application window and matching buttons within the window itself.

Select **Settings**, **Serial Port**, COM1 or COM2.

## Test the Connection

Press the **Version** button on the HH2Read window.

The following screen should appear:

The HH2 firmware version should be 2.8 or later.

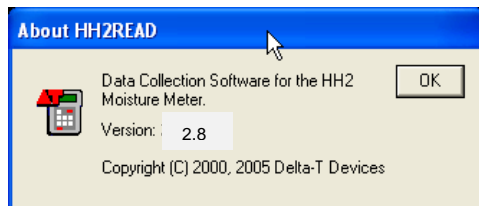

Whenever you send a request for information to the HH2 Moisture Meter it is also asked to report its internal clock.

Initially the clock display appears blank.

When the HH2 has finished dealing with the original request, the date and time should appear at lower left on the HH2Read window, looking something like this:



Typical date time display

The particular date time order will reflect your computer's Regional Settings, accessed from your Control Panel via the Start, Settings menu.

Once the HH2 has successfully received and processed a command or message from the PC it will display "Connected to PC"

The HH2 - PC link is now ready.

## Trouble Shooting

If you have problems with the PC software communicating with the meter then see PC Communications Problems on page 79.

---

# HH2Read Menu

## View Menu

This menu duplicates the left-hand row of buttons, giving information about the HH2 Moisture Meter:

- Firmware Version
- Battery Voltage
- Memory Available
- Table Status

### Version

Select **View, Version** to display the current version of the firmware, that is, the software embedded in the microprocessor in the Moisture Meter.

This is normally only needed when an upgrade or technical support is being considered.

### Battery

Select **View, Battery** to display the meter's battery status.

### Memory

Select **View, Memory** to display the number of readings stored and the total available.

### Available memory

During any given field session the available memory depends on how many times you change the meter settings.

The size of the memory also depends on whether you are using a Profile Probe - which contains many sensors, or a device such as an ML2, with a single sensor.

See also: Maximum Number of Readings on page 76.

### Table Status

Select **View, Table Status** to show what linearisation tables are loaded and their status.

Note: Equitensimeters do not have a table.

If your table is faulty the HH2 will replace it with the default table.

See Linearisation Tables Format, page 69, for guidance on correcting faulty tables.



# Settings Menu

This menu allows you to select the COM port and to set the clock.

## Serial Port

Use the **Settings, Serial Port**, identify the serial communications port of your PC. This requires a 9-pin D connector at the back of your PC for your RS232 cable. (If you do not have one, get and install a USB to RS232 converter).

## Clock

The **Settings, Clock** command displays the Set Clock dialog.

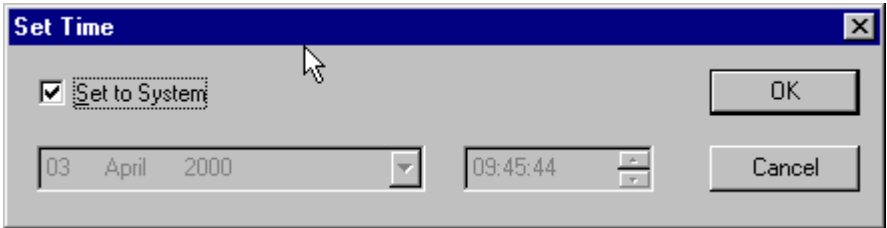

The current date and time setting for your computer is displayed in grey, and the Set to System box is checked.

The date and time format may be different, depending on the Regional Settings for your computer.

To accept your computer system clock date and time, click on **OK**. This resets the Moisture Meter clock to the same date and time.

To choose a different date or time, clear the Set to System check box to disable it.

The date and time selection boxes will now appear bold, in black and white, as follows:

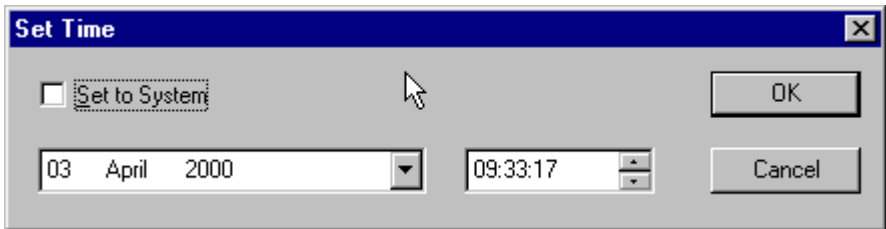

To change the date and time, use your mouse, and/or the left, right, up and down keys and the tab key.

**To change the date** you can click on the date select symbol :

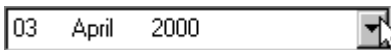

This displays the calendar:

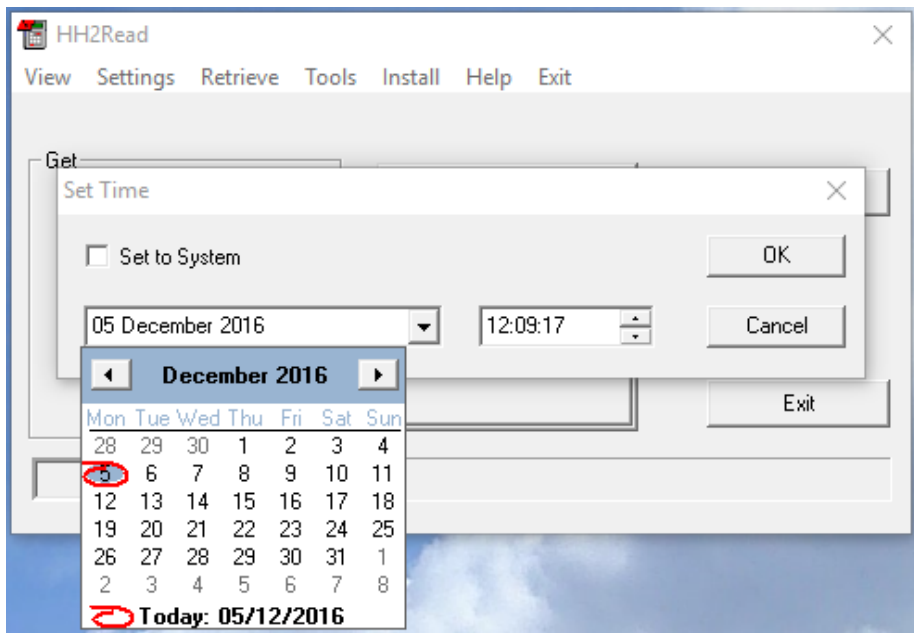

The date selection calendar

Select the desired date using your mouse, and also, or alternatively, use the left, right, up and down keys.

Either click on a date with the mouse or highlight it with the arrow keys and press return.

**To change the time**, use the mouse or tab and left or right arrow keys to select a particular field, i.e. months, and the up and down keys to change it.

This method can also be used for the date.

Click on OK on the Date Time dialog to send your chosen date and time to the Moisture Meter.

The updated date and time will appear at the bottom of the HH2Read window.

### **Note on Day, Month, Year Order**

The day, month, year order and date format displayed in HH2Read reflects the regional settings for your computer system. To change this, open Regional Settings via the Start Menu, Settings, Control Panel.

## Retrieve Menu and Button

This command collects all stored readings from the Moisture Meter and saves them to file on your PC.

Prior to collecting the data the following **Save As** dialog appears. If you accept the default and press Return it will save to a file called **hh2read.CSV** in the same directory as your HH2Read program.

It may be better to save your data into a different directory with a more descriptive file name.

When finished, a message appears indicating that the data was collected successfully.

Data is saved to file in a comma separated (.CSV) format. It can be viewed, analysed and graphed by spreadsheet packages such as Microsoft Excel.  
See also: Dataset Import Wizard - on page 61.

The .CSV dataset file also contains linearisation tables, soil calibration tables and other Moisture Meter settings.

## Tools Menu

From this menu you can select **Debug**.

## Install Menu

Use this menu to install sensor tables. There are two types:

Profile Probes and ThetaProbes have analogue outputs. **Linearisation tables**, with filenames ending in ".Lin" are provided for the HH2 to convert the analogue mV output into readings. Tables are permanently installed in the HH2 for use by all ML1, ML2, ML3, SM150, SM150T, SM200, SM300, PR1 and PR2 probes

WET sensors have digital outputs. Unique **calibrations tables** are provided on disk for each individual sensor, with file names ending in ".Cal". Only one digital sensor can be installed at any one time.

On one field trip you can read many different SM- series sensors, ML-series Thetaprobos, and Profile probes (both analogue and SDI-12) but you can only read one WET.

### Install, Linearisation Table

Options: SM150.LIN, SM150T.LIN, SM200.LIN, SM300.LIN  
ML1.LIN, ML2.LIN, ML2 SPECIAL.LIN, ML3.LIN  
PR1.LIN, PR2.LIN.

Linearisation tables for all these devices are permanently installed in the HH2 microprocessor. These are not lost in the event of battery failure.

Note the HH2 does not need a linearization table for the SDI-12 PR2 Probe as that is included in the probe itself.

Only install new tables to the HH2 if you wish to replace the default tables by your own custom tables - e.g. for unusual soils.

1. Connect your HH2 to your PC as described on page 54.
2. Select a device e.g. **Install, Linearisation Table, PR2** to display a Windows **Open** dialog.
3. Select the required table e.g. PR2.LIN.

The table will be parsed for correctness and if acceptable, installed.

Once installed, the Meter will be able to display readings for that device (once selected e.g. using Options, Device, PR2).

**Note:** Tables must conform strictly to the format, described below under Linearisation Tables.

Copies of the default factory set linearisation tables are supplied as separate files with the HH2Read software.

See also: Linearisation Tables Format on page 69.

### **Install, Sensor Calibration**

Installs calibration information for a particular WET sensor.

Options: WET

A unique calibrations table is provided on disk for each individual sensor, with file names ending in ".Cal". Only one digital sensor can be installed at any one time.

1. Connect your HH2 to your PC as described on page 54.
2. Select a device e.g. **Install, Linearisation Table, WET** to display a Windows **Open** dialog.
3. Select the required table e.g. WET201023.Cal.

Once the sensor calibration is installed, the HH2 will be able to display readings - providing the device is selected from the keypad (e.g. using Options, Device, WET).

**Note:** WET sensor calibrations cannot be altered by the user.

## **Help Menu**

Selecting Help will show information about the version of this software.

See also page 2

# Dataset Import Wizard

This PC program assists importing saved datasets into Microsoft Excel™. It is good for quick graphs, and for managing large amounts of data.

It is not an irrigation management program, but if you are comfortable with Excel you can do quite a lot with it. For instance, you can customise Excel to create weekly graphs of water content vs. depth - some people use this to help find the Refill Point.

1. Download the latest version of Dataset Import Wizard from [www.delta-t.co.uk](http://www.delta-t.co.uk).
2. Browse to your downloads folder and double click on the download, e.g. DTImpWiz-1.6.exe to install it, and follow the onscreen instructions.

This process will have installed the Dataset Import Wizard on you PC. In now needs to be installed into Excel as an Add-in

1. Select , **All apps, Dataset Import Wizard, Install Dataset Import Wizard.**
2. If prompted by Excel, select **Enable Macros**. Note that Excel's security settings must allow macros to run: refer to Excel Help.
3. Dataset Import Wizard will report that it has installed successfully, and will add **Import Dataset(s)** to the Add-in menu (or File menu in earlier Windows versions).

To Start Dataset Import Wizard: Start Excel, select Add-ins, Import Dataset(s) and follow the instructions (or File, Import Datasets in earlier versions of Windows).

## To Import Data into Excel

Before running the Wizard, retrieve and save a dataset file to your PC - see Upload Data to PC on page 12

Then go to **Excel**, select **Add-ins, Import Dataset(s)** to display the opening page of the Dataset Import Wizard, select the **Import Data from Dataset File(s)** option.

Note: Dataset Import Wizard will not import data directly from the HH2.

Always use **HH2Read, Retrieve** first to save the data as a .CSV file on your PC first, and import that.

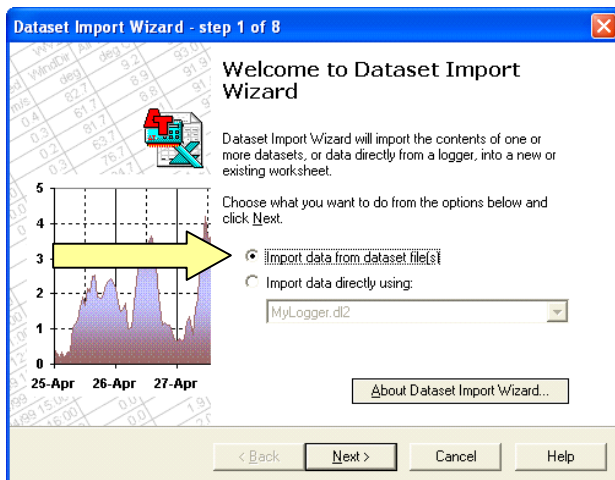

## References

See "**Dataset Import Wizard Notes for HH2 Users**" installed on your PC with HH2Read as a .PDF file.

In the **Examples** folder under HH2Read inspect the following:-

**PR1 Example Book 1.xls** shows what the wizard can do with Profile Probe data. Just accepting the wizard default settings will produce time series graphs.

**PR1 Example Book 2.xls** shows how you can simplify the data, make it easier to plot, and create a simple graph of water content vs. depth.

Click on **Help** when running the Dataset Import Wizard.

**Note:** the online Help was written primarily for DL2e data logger users. It has not been updated to support HH2.

The wizard can import data directly from DL2e, data loggers, but will not directly import data from the HH2. (Use **HH2Read, Retrieve** to save the data as a .CSV file on your PC first, and import that.)

# CSV Data File Layout

The following shows a sample of the data from an HH2 Moisture Meter, saved as a .CSV file using **HH2Read, Retrieve**, and opened in Microsoft Excel using **Add-ins, Import Datasets** Add-in command. The values here are not representative of expected soil moisture values. This is a demonstration of the format of the data output to a .CSV file.

The first information collected from the meter are calibration table values, followed by the values of all settings in the meter when the first reading was taken.

Subsequent readings appear in each row until the data runs out or one of the meter settings is changed e.g. the **Device** or **Display** options are changed.

If the settings are changed, then all the settings information is collected from the meter again and output to the .CSV file before the subsequent reading values appear in each row.

This example file shows all the output for the following devices:

SM200  
ThetaProbes types ML1 & ML2  
Profile Probes type PR1 & PR2  
Equitensiometers type EQ2

The .CSV data files for the following device is similar but does not include the calibration table:

WET Sensor type WET

Note : The layout is modified if you import the .CSV data file in Excel using the Dataset Import Wizard. Some indication of the difference is shown under "Layout of Profile Probe Readings" below.

See also the on-line document "**Dataset Import Wizard Notes for HH2 Users**" installed on your PC with HH2Read.

## Data File : Part 1 - Header

Delta-T Devices, HH2 Data Record  
 Versions: PC Softwa2.8.0.0 HH2 Firmv 2.8

Table >>	ML1 1.0	
Ready		
Units >>	mV	Sq.Rt.E
	0	1
	68	1.476
	101	1.621
	137	1.792
	201	2.089
	458	3.154
	553	3.556
	658	4.014
	764	4.489
	953	5.416
	1000	5.837
	1100	6.964
	0	0
	0	0
	0	0
	0	0
	0	0
	0	0
	0	0

ML2 1.0	
Ready	
Units >>	mV Sq.Rt.E
	0 1
	90 1.59
	220 2.21
	360 2.77
	480 3.17
	590 3.58
	690 3.99
	800 4.52
	900 5.05
	1000 5.85
	1050 6.8
	1110 8.96
	0 0
	0 0
	0 0
	0 0
	0 0
	0 0
	0 0

PR1 2.0	
Ready	
Units >>	mV Sq.Rt.E
	25 1.02
	50 1.23
	75 1.47
	100 1.73
	125 2
	150 2.28
	175 2.55
	200 2.82
	225 3.08
	250 3.36
	275 3.64
	300 3.96
	325 4.32
	350 4.76
	375 5.29
	400 5.94
	425 6.75
	450 7.75
	475 8.96
	500 8.96

PR2 1.1	
Ready	
Units >>	mV Sq.Rt.E
	80 1.004
	126 1.115
	280 1.682
	480 2.369
	573 2.755
	665 3.211
	745 3.67
	803 4.06
	847 4.415
	882 4.759
	912 5.117
	938 5.489
	961 5.891
	982 6.321
	1001 6.775
	1019 7.274
	1035 7.81
	1050 8.32
	1065 8.926
	1080 9.609

SM200 1.2	
Ready	
Units >>	mV Sq.Rt.E
	0 1.011
	30 1.453
	60 1.842
	90 2.179
	120 2.473
	150 2.729
	180 2.956
	220 3.218
	260 3.446
	310 3.701
	400 4.102
	600 4.956
	820 5.939
	960 6.571
	1040 6.96
	1100 7.29
	1150 7.61
	1200 7.982
	1220 8.205
	1800 9

SM800 1.0	
Ready	
Units >>	mV Sq.Rt.E
	0 1
	24 1.341
	53 1.704
	87 2.075
	123 2.412
	163 2.732
	209 3.047
	264 3.368
	335 3.726
	530 4.622
	640 5.152
	910 6.521
	1090 7.399
	1178 7.843
	1240 8.193
	1291 8.524
	1333 8.839
	1369 9.149
	1404 9.495
	1435 9.847

Soil >>	Organic	Mineral	Soil 1	Soil 2	Soil 3	Soil 4	Soil 5
A0 >>	1.3	1.6	1.6	1.6	1.6	1.6	1.6
A1 >>	7.7	8.4	8.4	8.4	8.4	8.4	8.4
Field Capacity	0.38	0.38	0.38	0.38	0.38	0.38	0.38

Typical layout obtained after importing the .CSV data file into Microsoft Excel:

Note: All the linearisation tables appear in the header, even if you are only using one sensor.



**Data File : Part 2 - Meter Settings and Readings**

Soil >>	Organic	Mineral	Soil 1	Soil 2	Soil 3	Soil 4	Soil 5
A0 >>	2.1	2.1	1.4	1.6	1.5	0	0
A1 >>>	7.7	8.4	7	7	7	7	7
Field Capacity	0.38	0.38	0.38	0.38	0.38	0.38	0.38
Device >>	ML1						
Root Depth >>				700			
Sensor Depth >>				0			
Soil >>				Organic			
Time	Sample	Plot	Device	m3.m-3	Error	mV	Error
28/03/2001 17:00:44	1	a	0	31.1		311.4	A
28/03/2001 17:01:44	2	b	2	31.1		311.4	A
28/03/2001 17:02:44	3	c	3	31.1		311.4	A
28/03/2001 17:03:44	4	d	4	31.1		311.4	A

Soil >>	Organic	Mineral	Soil 1	Soil 2	Soil 3	Soil 4	Soil 5
A0 >>	2.1	2.1	1.4	1.6	1.5	0	0
A1 >>>	7.7	8.4	7	7	7	7	7
Field Capacity	0.38	0.38	0.38	0.38	0.38	0.38	0.38
Device >>	ML1						
Root Depth >>				700			
Sensor Depth >>				0			
Soil >>				Organic			
Time	Sample	Plot	Device	mV	Error		
28/03/2001 17:04:44	5	A	1	501			
28/03/2001 17:05:44	6	B	2	501			
28/03/2001 17:06:44	7	C	3	501			
28/03/2001 17:07:44	8	D	4	501			

Typical ThetaProbe data file (continued from previous page).  
 After storing 4 readings the user changed the units. A new complete copy of the meter settings is stored, and appears at this point in the file.

### Layout of Profile Probe Readings

Note: these readings are preceded by the Linearisation tables - as in Data File Part 1, above

Root Depth >>			700											
Sensor Depth (mm) >>				100		200		300		400		600		1000
Soil >>				Organic		Organic		Organic		Organic		Organic		Organic
Time	Sample	Plot	Device	mm	Deflt	Error	mV	Error	mV	Error	mV	Error	mV	Error
28/03/2001 16:48:44	1	A	0	31.1		311.1		311.1		311.1		311.1		311.1
28/03/2001 16:49:44	2	B	10	31.1		311.1		311.1		311.1		311.1		311.1
28/03/2001 16:50:44	3	C	100	31.1		311.1		311.1		311.1		311.1		311.1
28/03/2001 16:51:44	4	D	255	31.1		311.1		311.1		311.1		311.1		311.1

Above: typical layout if you open the CSV data file in Microsoft Excel  
 (These readings are preceded by the Linearisation tables - as in Data File Part 1, above.)

Below: typical layout if you import the .CSV data file using the Dataset Import Wizard (Add-ins, Import Datasets command).  
 Note the changes in how the various HH2 Options have been displayed.  
 The Plot ID, in this example- "A" is added to the labels in the first row.  
 The Sample and Device labels still have their own columns.  
 The sensor depth is displayed in the row called "Channel".  
 The header row "Soil " has been dropped  
 See also: "Dataset Import Wizard Notes for HH2 Users"

Label	A.Sample	A.Device	A.VWC	A.mV	A.VWC	A.mV	A.VWC	A.mV	A.VWC	A.mV	A.VWC	A.mV
Channel			100	100	200	200	300	300	400	400	400	400
Sensor Type	PR1	PR1	PR1	PR1	PR1	PR1	PR1	PR1	PR1	PR1	PR1	PR1
Units			m3,m-3	mV	m3,m-3	mV	m3,m-3	mV	m3,m-3	mV	m3,m-3	mV
7-Jan-00 19:53:08	1	0	0.507	397	0.973	451	0.494	333	0.004	26	0.004	26
7-Jan-00 19:53:20	2	0	0.507	397	0.973	451	0.493	332	0.004	26	0.004	26
7-Jan-00 19:53:30	3	0	0.505	396	0.971	451	0.493	332	0.003	26	0.003	26

# About Soil Parameters a0 & a1

## Theory

Delta-T soil moisture sensors respond to the soil dielectric constant  $\epsilon$ , which is strongly dependent on the water content. Several authors:- Whalley , and White, Knight, Zeggelin and Topp, have shown that there is a simple relationship between the complex refractive index (equivalent to the square root of  $\epsilon$ ), and the volumetric water content ,  $\theta$ , as follows:

$$\sqrt{\epsilon} = a0 + a1 \times \theta$$

## About a0 and a1

These soil specific parameters are unique for each soil type. They are used with a linearisation table, in the HH2, to convert the sensor output, in mV, into soil moisture readings.

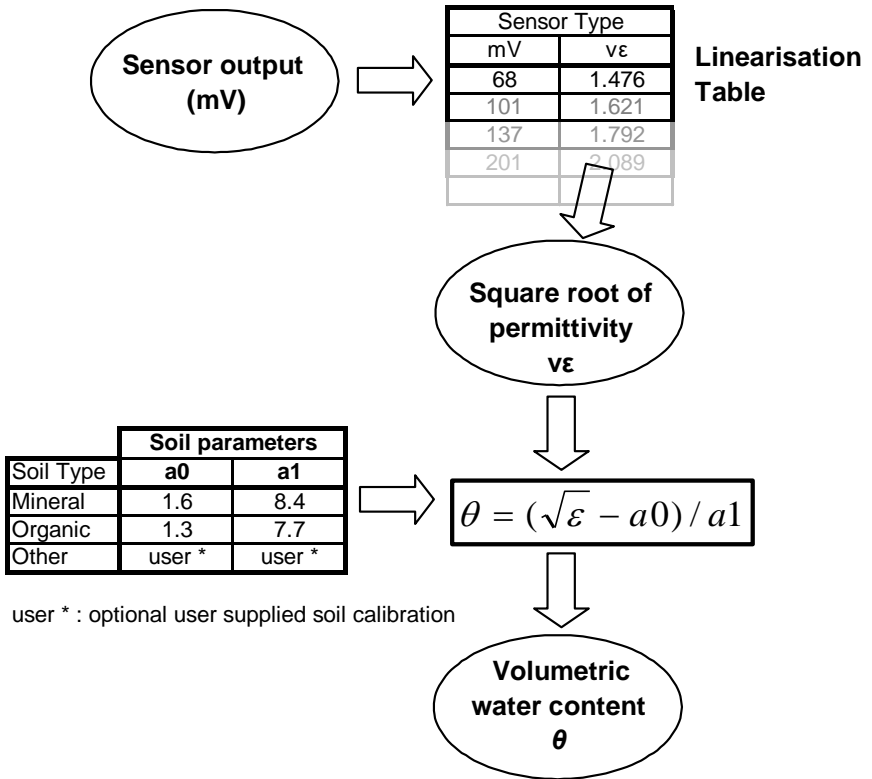

These soil parameters are a convenient and efficient way of describing the calibration curves for different soil types without the overhead of a unique linearisation table for every different soil.

It is also a lot easier experimentally to derive an  $a_0$  and  $a_1$  for your soil than to measure the complete calibration table.

**For optimum accuracy** you should obtain these parameters,  $a_0$  and  $a_1$ , experimentally for your soil as described in your sensor user manual. Then enter these via the **Soil Set-Up** menu in the HH2.

### Using Default values of $a_0$ & $a_1$

Alternatively you can choose the **Mineral** or **Organic** option in the **Soil Types** sub menu. You may lose some absolute accuracy (up to ~ 4% volumetric water content) but it is easier. Soil parameters are permanently installed in the HH2 as follows:

	$a_0$	$a_1$
Mineral soils	1.6	8.4
Organic soils	1.3	7.7
Peat mix	1.16	7.09
Coir	1.16	7.41
Min. wool	1.04	7.58
Perlite	1.06	6.53

These values were derived using the method described by Roth et al 1992 – see below.

The other references below trace the validation of the method.

### References

1. Topp, G.C., Davis, J.L. and Annan, A.P. 1980  
Electromagnetic determination of soil water.  
Water Resour. Res. 16(3) 574-582
2. Roth, C.H., Malicki, M.A. and Plagge, R. 1992  
Empirical evaluation of the relationship between soil dielectric constant and volumetric water content as the basis for calibrating soil moisture measurements.  
Journal of Soil Sci. 43, 1-13
3. Whalley, W.R. 1993  
Considerations on the use of time-domain reflectometry (TDR) for measuring soil moisture content.  
Journal of Soil Sci. 44, 1-9
4. White, I., Knight, J.H., Zegelin, S.J. and Topp, G. C. 1994  
Comments on “Considerations on the use of time-domain reflectometry (TDR) for measuring soil moisture content.” by W R Walley.  
Journal of Soil Sci. 45, 503-508

# Linearisation Tables Format

---

## .LIN File Format

The HH2 linearisation table for SM series, Thetaprobe and Profile Probe sensors may be changed by loading a ".lin" format file from the PC using HH2Read. This facility is provided to enable Delta-T to provide updates to these tables.

**These tables contain pairs of mV values and square root of the soil permittivity values.**

These are text files which you can view with any text editor, such as Notepad under Windows.

The file must be formatted as follows:

<Label><CR><LF>

<Number of Data Points n><CR><LF>

<mV Value 1> , <Converted Value 1><CR><LF>

```
"      " 2 ,      "      " 2 "      "
```

```
"      "      "      "      "
```

```
"      "      "      "      "
```

<mV Value n> , <Converted Value n><CR><LF>

Each line must be terminated with the ASCII codes for Carriage Return CR and Line Feed LF.

**<Label>** The first line of the file contains exactly 10 characters, including white space, describing the table - such as its name and version information - to be stored in the HH2.

**<Number of Data Points n>** The next line contains the number of values in the linearisation table. This must be a 2 digit integer (zero padded) to indicate the number of data point pairs in the table. It can have the value 02 to 20.

**<mV Value n>,<Converted Value n>** The remaining lines contain pairs of linearisation table values. There can be between 2 and 20 pairs of data points. A comma separates the two values. If there are less than 20 data point pairs then the remaining rows should be padded with zeros as shown in the example below.

**<mV Value n>** This represents the mV output signal from the sensor. The mV value is an integer value between 0 and 2000. The values are zero padded to ensure that they are always of the form nnnn e.g. 0013.

**<Converted Value n>** This represents the square root of the soil permittivity. The converted value must be a number between 0 and 999.999, to three decimal places. The values are zero padded to ensure that they are always of the form nnn.nnn e.g. 001.123. See your sensor user manual for information about the mV output signal and the soil permittivity.

The mV values must always increase from the lowest mV value first in the list, to the highest last in the list.

The converted values must only increase or decrease but not both.

A decimal point "." not a comma "," must be used as the decimal separator in the numbers used for the Converted Values.

### Example Linearisation Table:

ML1	
20	
0000,001.000	mV reading, integer
0068,001.476	
0101,001.621	Square root of soil permittivity
0137,001.792	
0201,002.089	
0458,003.154	
0553,003.556	
0658,004.014	
0764,004.489	
0933,005.416	
1000,005.837	
1100,008.964	
0000,000.000	
0000,000.000	
0000,000.000	
0000,000.000	
0000,000.000	
0000,000.000	
0000,000.000	
0000,000.000	
0000,000.000	
0000,000.000	

The HH2 contains factory set linearisation tables.

You can upgrade or change these tables with .LIN files using HH2Read.

If the meter should lose power, then the memory containing readings and these new tables will be lost and replaced by the factory set tables. In that case you will have to reload any newer tables.

# Changing the Battery

The HH2 unit works from a single 9 V PP3 type battery.

When the battery reaches 6.6V, (about 25% left) the HH2 displays:



On receiving the above warning, upload your data to your PC next, or replace the battery. Observe the following warnings:

---

***WARNING 1: Disconnect your device (sensor), particularly Profile Probes, immediately on receiving this low battery warning. Failure to heed this warning could result in loss of data.***

***WARNING 2: Ensure the HH2 is sleeping before changing the battery.***

***WARNING 3: Once the battery is disconnected you have 30 seconds to replace it before all stored readings are lost.***

---

If you do not like this prospect, be reassured that your readings are safe indefinitely, (provided that you do disconnect your sensor and you do not disconnect your battery).

If you continue to use the HH2 despite the low battery warning it will eventually stop working in order to protect saved readings. At this point it will not upload data to the PC. To recover the data now you must change the battery. Again, you must connect a new battery within 30 seconds of disconnecting the old battery before data is lost.

The meter will, when starting up after a battery change always check the state of its memory and will attempt to recover any readings held. So even if the meter has been without power for more than 30 seconds, the meter may still be able to retain any readings stored.

Readings recorded in memory and any new linearisation tables loaded by you will be lost if the memory has no power for too long. If you did add new linearisation tables (see page 59) then you will have to re-load them.

## To Replace the Battery

When the HH2 reaches its low point, replace the battery:-



Battery compartment - takes one PP3 battery



Unclip the back panel by pressing downwards on the clip at the rear. You will find the connector as shown above. It can only be fitted one way.

Let the HH2 sleep then remove the current battery and replace it with a new one. You will have at least 30 seconds to replace the removed battery before the memory will be lost.

Place the newly connected battery in the compartment and refit the cover, making sure all the wires are tucked inside the case

---

*Note: in case of problems changing the battery, it is advisable to download any readings stored in the meter before replacing the battery. However, if you are working away from a PC, then you should have enough time to replace the battery without losing any readings.*

---

The HH2 when using a new battery can take approximately:

2000 SM150, ML2 or Equitensiometer readings

1400 PR2 readings

before needing to replace the battery.

---

*Note: this number of readings is presented as a guide only. Delta-T only guarantees this number of readings under perfect conditions. The number of readings can be reduced if the unit is kept awake, if the unit is used in temperatures which are not suitable for the battery, or if the battery has poor performance and loses power rapidly.*

---



## The battery display

The battery voltage is only read when the Moisture Meter wakes up. The value shown on the display, from the **Options, Status** menu, is that read when the meter last read the battery voltage. The voltage is not read again until the Moisture Meter next wakes from being asleep.

---

*Note: the Moisture Meter takes a few seconds to read the battery voltage while waking up. If you interrogate the meter with the PC software, while it is waking, then the meter will not be able to provide the battery voltage. You may also get an error report if you try to get the battery voltage from the PC. So wait a couple of seconds for it to wake up.*

---

---

*WARNING: when the meter measures the battery voltage, power will be applied to any attached device. Soil moisture devices supplied for use with the HH2 by Delta-T are unaffected by this. No support for non- Delta-T Devices is implied by this statement.*

---

### The Battery and Holder

The battery must be 9V PP3 type battery - do not use any other type of battery or any other power supply. The meter may be damaged by a power source not recommended by Delta-T.

---

***Send the HH2 to sleep before changing the battery.***

---

When replacing the battery in the battery compartment, do not pull at the battery leads because they may become disconnected inside the meter and the HH2 will have to be returned for repair.

This battery is only measured when the unit is woken, so to properly check your battery status, allow the HH2 to sleep first, then press ESC to wake it.

# Care and Maintenance

This chapter explains some rules regarding the care and maintenance of the Moisture Meter to ensure that you can get the best performance from the meter for as long as possible.

## **The Case**

The Moisture Meter is made of rigid plastic which is solid enough for daily use carrying around outside. It is designed to withstand everyday knocks and scrapes.

However, the case is not designed for heavy impact such as falling from a great height or being crushed by large objects.

The HH2 is poorly protected against water ingress. If the meter is partially or wholly immersed in water or is used in heavy rain, then the unit will fill with water. If water gets inside the unit, then there may be non-repairable damage with the loss of all readings recorded.

The case may be cleaned with a damp cloth. Do not use an abrasive material or chemical cleaner. These may deform the finish of the case.

## **The Keys and LCD Display**

The keys and LCD display are designed to withstand occasional knocks and scrapes. The keys are designed for routine use over many years and the display should provide a clear image for the same period.

The LCD has a plastic screen to prevent some damage, but a direct hit from a sharp or heavy object may penetrate and damage the display.

Do not use an abrasive material or chemical cleaner to clean the display because they may damage the plastic protection, making the screen difficult to read.

## **25-way D-Connector**

The 25-way D-connector is a male connector into which a female connector is inserted. The pins in the connector can be damaged if forced together with a damaged or dirty female D-connector.

## **Use of the HH2**

The HH2 has been designed for use only with specified Delta-T sensors. Delta-T do not recommend its use with third party sensors and will not be responsible for any damage caused by the use of the HH2 with non-Delta-T products.

# Technical Reference

---

## Specifications

Soil moisture range	Zero to saturation, 0 to 1500 mV
Measurement Accuracy	$\pm$ (0.13% of mV reading + 1.0mV)
Resolution	1 mV
Memory	Up to 5000 readings, see table - Maximum Number of Readings on page 76
Battery	9V Alkaline Cell(PP3)
Battery Life	6500 readings for SM200 or ThetaProbe (typical) 4500 readings for Profile Probe and Equitensimeters (typical)
Sealing/environment	IP52 Protected from deposit of dust and water drops falling at an angle of 15 degrees from the vertical on the front face only.
Temperature range	0 - 40 °C.
Mechanical Shock	Should survive a 1m fall, but there may be damage to the sealing of the unit which could cause leakage of water and subsequent failure.
EMC	European Union EMC Directive 89/336/EEC, See also <i>Notices</i> inside front cover & page 78
Size/Weight	150 x 80 x 40 mm, 450g.
Display Panel	16 x 2 character LCD with 7 button keypad
Connector	1 x male 25 pin D connector for RS232 link to PC and also for connecting sensors. Complete with push-on protective cap.
HH2Read PC software	Data Collection software for Windows PC (95...XP) on 3.5" disk. Enables data collection, saved to file in Comma Separated Format.  Dataset Import Wizard: Simplifies importing data into Microsoft Excel

# Memory

## Maximum Number of Readings

	Worst case	Best case
PR2/6	166	782
SM200, ML1,ML2, EQ1,EQ2	227	2186
WET	204	1272

**Worst Case:** Every possible configuration changes per reading.

**Best Case:** The soil configurations, and sample configurations remain static for every reading.

Note: These figures may be out by 1 or 2 readings

## 25-way D-connector

The Moisture Meter uses a 25-way male connector to connect to either a PC (via an RS232 cable) or to a sensor.

The following diagram indicates which of the pins on the D-connector are used for which function. The HH2 has been designed to avoid sharing pins for the sensor and PC connections to prevent accidental damage to attached equipment.

See earlier sections of this document for a detailed description of the connector accessories, which Delta-T can provide for connecting sensors to the HH2.

### 25-way D-connector Pin Arrangement

Note: the pins shown here are those seen from viewing the D-connector on the HH2 when holding the meter in your hand.

All other pins are unused. They are not connected within the HH2.

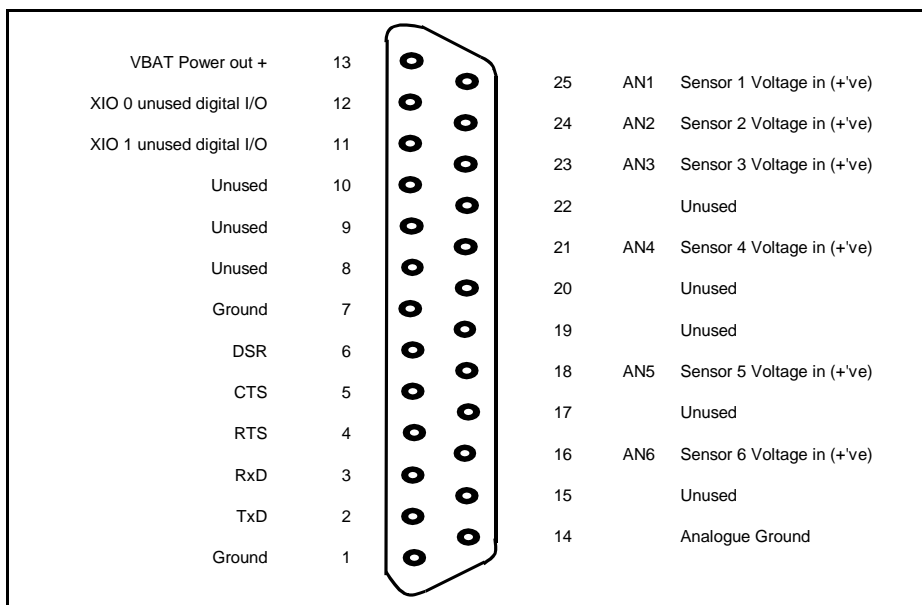

See also **Error! Reference source not found.** on page **Error! Bookmark not defined.**

# EMC Certificate



## Certificate of Conformity

Delta-T Devices Ltd has assessed the listed product & declares that it conforms with the following standards, when used as described in the product's User Manual:

**EMC** Under EU EMC Directive 89/336/EEC:  
**BS EN 61326:1998 class B**, comprising:

Immunity: IEC 1000-4-2	Enclosure	ESD
IEC 1000-4-3	Enclosure	Electromagnetic
IEC 1000-4-4	Input/output	Burst
IEC 1000-4-5	Input/output	Surge
IEC 1000-4-6	Input/output	Conducted RF
Emission: CISPR 16-2	Enclosure	RF Emissions

**Safety:** 73/23/EEC Low Voltage Directive

Product approved: **HH2 Moisture Meter**

Date of Approval: 12/6/2000

Test Engineer and authorised representative: T.K.Bragg

Signed:  Date: 12/6/00

As Chair of the Management Committee, I, Peter Cockerton, certify that T.K.Bragg is our authorised representative:

Signed:  Date: 12/6/00

Delta-T Devices Ltd. 128 Low Road, Burwell, Cambs, CB5 0EJ, England, U.K.  
Tel: (+44) 1638 742 922 Fax: (+44) 1638 743 155

---

# Troubleshooting

See also: Error Messages on page 84.

## Problems

### To Cold Boot the HH2

1. Disconnect the battery.
2. Short out the battery connection terminals with a metal object, e.g. a screwdriver blade.
3. Reconnect the battery: snap the connector in place in a single continuous action.
4. While doing so, observe the display and ensure that:
  - a. the entire display blacks out
  - b. no error messages are displayed
  - c. the title screen 'Delta-T Devices Moisture Meter' is displayed.

### PC Communications Problems

Check that the meter is showing:

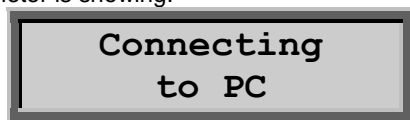

..to indicate that it is ready to receive PC requests.

**Is the RS232 cable correctly fitted** between the PC and HH2? Check that the cable connectors fit tightly. There may be problems with the 9-25 D adaptor at the HH2 end. You may have to try swapping with other cables or adaptors.

**Are you using the right COM port?** Check which serial port is used on the PC. Check that the HH2Read software is set to use that COM port.

**Have you got the right type of RS232 cable?** (Delta-T Sales Code HHRS2).

The normal RS232 cable has female connectors at each end (and has crossed over lines between some pins). Do not confuse these with RS232 modem cables. Modem cables have male and female connectors (and are wired straight through).

WET sensor will not read

(Common with WET kit users) The HH2 battery runs low and when it is changed, it is no longer possible to read the WET sensor. This can occur if the HH2 has resets itself. This can occur if you short the two battery terminal together.

Solution: Reinstall the WET sensor calibration file into to the HH2.

See

Install WET Sensor Calibration on page 37.

**WET sensor will not read certain substrates.**

Your HH2 may need the WET substrate calibrations upgrade.

See

Install WET Sensor Calibration on page 37.

### **HH2 displays 'Sys Error'.**

The most likely cause of 'Sys Error' is corrupted calibration values or other configuration settings. HH2 firmware (PROM) Versions earlier than 1.08 were vulnerable to corruption of calibration values if the battery was not connected cleanly.

Solution: Cold Boot the HH2.

See To Cold Boot the HH2 on page 79

Upgrade your HH2 to v2 firmware as soon as possible. Contact Delta-T.

### **Readings Corrupt, Store? prompt missing**

On initial power up the HH2 reports a sequence of messages such as Readings Corrupt OR, after taking a reading, the HH2 fails to display the "Store?" prompt and it is not possible to record readings.

To clear the error condition cold-boot the HH2 but note that this will destroy any data that are already stored. So try to download any stored readings before proceeding (no guarantee of success if readings are corrupted).

See To Cold Boot the HH2 on page 79

The HH2 displays the error condition only when it first detects the error, normally on power-up, e.g. "Readings Corrupt" messages that occur when it fails to cold-boot correctly. It then patches up the error where possible, for example, restoring the default linearisation tables from ROM, and resumes quasi-normal operation. This means that it is able to take readings and doesn't report the error any more.

Error code 7 – on HH2Read

This problem is common when the RS232 cable is pulled out of the HH2 half way through downloading readings or because the HH2 has detected an error condition with some of the readings. Unfortunately if this has happened the readings can no longer be accessed and the only way to restore the HH2 will be to cold boot it.

Note: readings will be lost.

See To Cold Boot the HH2 on page 79

### **Display is Blank**

The meter will sleep when not used for more than 30 seconds. This means the display will go blank.

First check that the meter is not sleeping by pressing the Esc key. The display should become visible instantly.

If the display remains blank, then try all the keys in case one key is faulty.

If you have a voltmeter, then check the battery exceeds 5 Volts. If it drops below this value then the performance of the meter can be intermittent. If it is a long way below 5 Volts then the meter may not work at all.

Try replacing the battery.

If you are in bright light, then the display may be obscured by the light shining on the display. Try to move to a darker area or shade the display.



### **Incorrect Readings being obtained**

Check the device is connected to the meter correctly.

If using a converter, then check that it is not damaged. If you have spare converters then try one of those.

If you have fitted a connector to the device yourself using the Delta-T adapter kit (type DSK1) then check that the wiring has been correctly applied and that the wiring connections are good with no interference from other connectors, for example solder applied to one wire may be touching another.

Check the sensor user manual. Check that you are using it correctly e.g. is it being inserted into the ground correctly?

Check the user manual to see if the device is being used in soil conditions which the device is incapable of measuring.

Has the meter been set up with incorrect soil moisture values e.g. a0 and a1 values may be incorrect for this soil type?

If you are getting zero for mm Deficit check you have entered a value for Root Depth.

If you are getting a negative value for mm Deficit you may be using too low a value for Field Capacity.

Has the meter been set up with the correct device?

If you have other equipment to measure the device then do so. You can check if the results are the same and hence prove whether there is a fault with the device.

### **Zero Readings obtained**

If you are getting zero for mm Deficit check you have entered a value for Root Depth.

If the soil moisture value is always reading zero, then an additional test to those in the previous section is to check the battery.

Sensors will only return a signal voltage if the meter applies a voltage. This voltage is taken from the meter's battery.

Check the battery voltage is above 5V. Any less and the device may not be able to take a reading.

Note: WET sensors need more than 6 V.

### **Readings can't be stored**

This may occur because the HH2 has detected an error. It will have reported it once and partially repaired it.

To clear the error condition cold-boot the HH2. Cold-booting will destroy any data that are already stored, so you might want to try (no guarantee of success if readings are corrupted) to download any stored readings before proceeding.

See To Cold Boot the HH2 on page 79.

### **Meter will not sleep**

If the meter is not sleeping, then check that there is no RS232 communication from the PC and that there is not a fault from the attached device which may be constantly or intermittently applying power to the meter inputs.

### **Meter will not respond**

If the Moisture Meter appears to lock up and is not responding to key presses try disconnecting it if it is attached to a sensor or PC.

If this fails try resetting the Moisture Meter to its default values by cold-booting it.

---

*Doing this will lose all your readings and Options settings!*

---

See To Cold Boot the HH2 on page 79.

### **Error with Profile Probe**

When only mm Deficit is selected, only the first Error field is used by the HH2. The others stay blank.

If an error occurs when reading any of the sensors in a Profile Probe then the Moisture Meter reports an error on the display. If you are recording mm deficit it is recommended that you change the units displayed, via the Options, Display menu, to two sets of units, i.e. mm Deficit + %vol, or mm deficit +  $\text{m}^3.\text{m}^{-3}$ . This will allow all good readings to display and be recorded, and the Error fields will indicate the nature of the error affecting the other, faulty, sensors.

This does not fix the problem, but at least it allows you to recover the good data.

If faulty sensors exist and are all lowest in the PR2 then the HH2 will use the lowest good sensor and extrapolate down to the Root Depth to calculate mm deficit.

If a faulty sensor exists which is higher than a good sensor in the PR2 then the HH2 does not try to calculate mm Deficit, and reports an error.

## Zero mm Deficit

The default root depth in the HH2 is zero. If you do not enter a root depth for your soil you will get zero for mm deficit.

Do not assume that the default values for Field Capacity pre-set in the HH2 will give reliable results for your particular soil. It is much better to independently measure it enter it into the HH2. See Calculating Field Capacity on page 96.

## Negative readings

Negative soil moisture readings can be obtained at very low soil moisture values.

This can be frustrating and confusing.

This can be a result of the approximation used when representing a large population of empirical test data of soil moisture vs. permittivity as a simple equation or table.

The error indicates a limitation of the permittivity based methods of soil moisture measurement.

Note the impact of the soil moisture coefficient  $a_0$  in the following equation when water values are low:-

$$\text{Water content } \theta = (\sqrt{\epsilon} - a_0) / a_1$$

where  $\sqrt{\epsilon}$  is the square root of the dielectric permittivity of the soil and the soil parameters  $a_0=1.6$  and  $a_1=8.4$  are used to represent a Mineral soil.

When  $\sqrt{\epsilon}$  is less than 1.6 (i.e. in very dry soil) the meter will report a negative reading. This is a consequence of the fact that no two soils are exactly the same.

The permittivity measurement method is sufficiently good for most purposes, using generic look-up tables representative of a range of soils. Most users are happy to use the generic Mineral Soil calibration provided by us.

If necessary you may calibrate your own soil and derive and enter your own soil parameters  $a_0$  and  $a_1$ .

Dataset Import Wizard reports 'Unexpected error 0x80041004' in a HH2 dataset.

This is what you get when you open a HH2 dataset CSV file in Excel, then save it using **Save As... .CSV** file. Although Excel saves the file according to the .CSV rules with comma separators etc, the data you get in the file is a .CSV version of what you see on screen and is subtly different from the original file contents in certain points of detail: especially spacing and number and date/time formatting. Dataset Import Wizard expects a file format that is exactly as retrieved from the HH2, and is unable to interpret the Excel version.

---

# Error Messages

## Error Codes

Errors detected by the HH2 are reported in retrieved data sets.

Errors detected by the PC software HH2Read are reported immediately on your PC screen.

The HH2 display normally shows the reading and its units. If an error occurs during a reading, the HH2 display shows an error message. If you press Store an error code is saved with the reading. This appears in the data file when retrieved by your PC.

An error field (column) is always saved to the right of each reading saved to file, even if no errors occur.

If no error occurs it contains a single blank (space) character " ".

### Error codes in retrieved data sets:

Display	Code	Description
Under-rng	L	Under-range: the reading is too low
Over-rng	H	Over-range: the reading is too high
Below tbl	O	A linearisation table passed to the HH2 has a value which is too low
Above tbl	I	A linearisation table passed to the HH2 has a value which is too high
Sys Error	V	A fault occurred in the HH2.
No Sensor	C	Sensor not detected – device may be disconnected or a sensor may be faulty; Also appears with any non-standard Profile Probe which does not have 4 or 6 sensors.
Too dry	D	Too dry to compute pore conductivity reading
Corrupt	R	EC2/WET reading message is corrupted
No number	N	Arithmetic operation resulted in an invalid IEEE floating point value
Overflow	W	Arithmetic overflow
Underflow	U	Arithmetic underflow
No table	T	Table or calibration is missing

## **Battery Low**

Battery voltage is dangerously low - below 5.4 Volts.

Disconnect any sensor immediately and replace the battery. See Changing the Battery on page 71

The battery voltage is too low to operate. The unit will attempt to go to sleep immediately after being woken up, and cannot be operated until the battery has been changed. This is to preserve any configurations and readings stored in memory, as taking further readings or operating the units CPU may cause the unit to lose or corrupt any stored readings.

The battery is only measured when the unit is woken so to properly check your battery status allow the HH2 to sleep first, then press ESC to wake it.

## **Error code 7**

See **Error code 7 – on HH2Read** on page 80.

## **Failed memory Full**

Failed (to store readings) because memory is full.

## **Failed - Please erase data**

Failed to store readings because an error that disables the storage of reading has occurred.

## **Linearisation Table Corruption**

A corrupt linearization table was detected. No subsequent readings can be stored.

Readings can still be taken using the default linearisation tables, but further readings cannot be stored until all readings in memory have been erased.

See also: Readings can't be stored on page 82.

## **Live Sensor Connected**

The HH2 cannot sleep. A sensor may be connected to one of the analogue inputs which is feeding a live voltage to the HH2. The sensor should be disconnected from the unit to allow it to go to sleep.

This error only appears where the unit wishes to enter sleep.

It can also be caused by keeping your finger on the ESC button

## **Memory Failure, Readings Corrupt, Settings Corrupt**

See Readings can't be stored on page 82.

A memory error occurred.

Try to save any readings to the PC.

Then select the **Erase** option from the **Data** menu and then try resetting the meter by removing battery power for at least 30 seconds.

See also To Cold Boot the HH2 on page 79.

If the problem persists please ask your supplier how to return the unit for repair.

## **No Sensor**

"No Sensor" means that no sensor could be detected when taking a reading. This could be due to poor cabling.

## **No Table**

"No Table" means table or calibration is missing. When the unit first initialises, or when a battery is changed and the unit reinitialises, linearisation tables for each sensor are automatically loaded by the unit. Custom tables can then be loaded by the user.

If a default table or a custom table subsequently becomes corrupt and you attempt to take a reading, the error "No Table" is displayed.

## **Over-range**

The sampled voltage value was higher than the HH2 can handle, or the resultant soil moisture value was calculated to be greater than 1. As soil moisture is a ratio, this is reported as too high.

## **Please Change Battery**

The battery voltage has dropped below the safety warning threshold of 6.6V.

Change your battery, (but first retrieve your data) :  
see Changing the Battery on page 71.

Taking further readings may add a sufficient additional load (most probably with a PR1) to the battery that will cause the voltage to drop below the CPU operational threshold. If that happens the integrity of the readings cannot be guaranteed as the lower voltage might cause the CPU to reset and/or corrupt readings.

The error is a warning only, and is displayed directly after power on and does not prevent the user using the unit in any way.

The battery is only measured when the unit is woken so to properly check your battery status allow the HH2 to sleep first, then press ESC to wake it.

## **Sys Error**

See HH2 displays 'Sys Error' on page 80.

**Under-range**

The sampled voltage value was lower than the HH2 can handle, or the resultant soil moisture value was calculated to be negative. As soil moisture is a ratio, this is reported as too low.

# Warranty and Service

---

## Terms and Conditions of Sale

Our Conditions of Sale (ref: COND: 1/07) set out Delta-T's legal obligations on these matters. The following paragraphs summarise Delta T's position but reference should always be made to the exact terms of our Conditions of Sale, which will prevail over the following explanation.

Delta-T warrants that the goods will be free from defects arising out of the materials used or poor workmanship for a period of two years from the date of delivery.

Delta-T shall be under no liability in respect of any defect arising from fair wear and tear, and the warranty does not cover damage through misuse or inexpert servicing, or other circumstances beyond their control.

If the buyer experiences problems with the goods they shall notify Delta-T (or Delta-T's local distributor) as soon as they become aware of such problem.

Delta-T may rectify the problem by replacing faulty parts free of charge, or by repairing the goods free of charge at Delta-T's premises in the UK during the warranty period.

If Delta-T requires that goods under warranty be returned to them from overseas for repair, Delta-T shall not be liable for the cost of carriage or for customs clearance in respect of such goods. However, Delta-T requires that such returns are discussed with them in advance and may at their discretion waive these charges.

Delta-T shall not be liable to supply products free of charge or repair any goods where the products or goods in question have been discontinued or have become obsolete, although Delta-T will endeavour to remedy the buyer's problem.

Delta-T shall not be liable to the buyer for any consequential loss, damage or compensation whatsoever (whether caused by the negligence of the Delta-T, their employees or distributors or otherwise) which arise from the supply of the goods and/or services, or their use or resale by the buyer.

Delta-T shall not be liable to the buyer by reason of any delay or failure to perform their obligations in relation to the goods and/or services if the delay or failure was due to any cause beyond the Delta-T's reasonable control..

## Extended Warranty

All Delta-T Devices products have a two year (24 month) warranty as standard, but the ML3, SM150 and SM300 soil moisture sensors benefit from a 5 year warranty (60 months from date of delivery). Simply register the product(s) with us via and we will add 3 more years to the standard warranty, extending it to the full 5 years duration. To qualify, products must be registered within 12 weeks of delivery.

All SM150s, SM150Ts, SM300s and ML3s sold since 1 January 2016 are eligible. Visit the Support Section of our website [www.delta-t.co.uk](http://www.delta-t.co.uk) to register your sensor for an extended 5 year warranty.



---

## Service, Repairs and Spares

Users in countries that have a Delta-T distributor or technical representative should contact them in the first instance.

Spare parts for our own instruments can be supplied and can normally be despatched within a few working days of receiving an order.

Spare parts and accessories for products not manufactured by Delta-T may have to be obtained from our supplier, and a certain amount of additional delay is inevitable.

No goods or equipment should be returned to Delta-T without first obtaining the return authorisation from Delta-T or our distributor.

On receipt of the goods at Delta-T you will be given a reference number.

Always refer to this reference number in any subsequent correspondence.

The goods will be inspected and you will be informed of the likely cost and delay.

We normally expect to complete repairs within one or two weeks of receiving the equipment. However, if the equipment has to be forwarded to our original supplier for specialist repairs or recalibration, additional delays of a few weeks may be expected

---

*. WARNING: before returning a meter to Delta-T you should collect any readings stored in the meter. If the battery should become disconnected or run down whilst in transit to Delta-T then the meter readings may be lost.*

---

---

## Technical Support

Users in countries that have a Delta-T distributor or technical representative should contact them in the first instance.

Technical Support is available on Delta-T products and systems. Your initial enquiry will be acknowledged immediately with a reference number. Make sure to quote the reference number subsequently so that we can easily trace any earlier correspondence.

In your enquiry, always quote instrument serial numbers, software version numbers, and the approximate date and source of purchase where these are relevant.

### Contact details:

	<b>Technical Support</b>	<b>Tel:</b> +44 1638 742922
	<b>Delta-T Devices Ltd</b>	<b>Fax:</b> +44 1638 743155
	<b>130 Low Road</b>	<b>E-mail:</b> <a href="mailto:tech.support@delta-t.co.uk">tech.support@delta-t.co.uk</a>
	<b>Burwell</b>	<a href="mailto:sales@delta-t.co.uk">sales@delta-t.co.uk</a>
	<b>Cambridge CB25 0EJ</b>	<b>Web:</b> <a href="http://www.delta-t.co.uk">www.delta-t.co.uk</a>
	<b>England (UK)</b>	

# Accessories

---

## 9-pin RS232 Connector

9-pin to 9-pin RS232 cable

---

## 25-pin to 9-pin RS232 Converter

A moulded connector containing 25-way female D Connector and a 9-pin male D connector, suitable for connecting the HH2 to a standard RS232 cable.

---

## DIN to 25-pin RS232 Converter

25-pin female connector for HH2 type C-HH2-DIN. Suitable for ThetaProbe type ML2x/p or Equitensimeter type EQ2/p. Provides flying socket for sensor DIN plug.

---

## Tajimi to 25-pin RS232 Converter

25-pin female connector for HH2 type C-HH2-T. Suitable for ThetaProbe type ML2x/t or Equitensimeter type EQ2/t. Provides socket for sensor IP68 Tajimi plug.

---

## PR2 to HH2 cable

1.5 m cable connects PR2 Profile Probe to HH2 Moisture Meter, Type PRC/d-HH2. IP68 M12 connector (female) to 25-way D-socket (IP54).

---

## PR2 SDI-12 to HH2 Cable

1.5m cable connects PR2 SDI-12 Profile Probe to HH2 Moisture Meter. Type SDI-12/5W-HH2. IP68 M12 connector (f) to 25-way D-socket (IP54).

See also Unpacking on page 5.

# Water Deficit Explained

**Saturation** is the moisture content at which all the air within the pores has been replaced by water. It's not a stable situation because the water will immediately start to drain through. It's a property of soil type only.

**Field Water Capacity** (or **Field Capacity**) is the moisture content obtained when a saturated soil has been allowed to drain (sometimes taken as 2 days later, sometimes when drainage has become "negligible").

It's a property of soil type only, and typically varies between 0.1 for sandy soils up to about  $0.45\text{m}^3\cdot\text{m}^{-3}$  for clay soils.

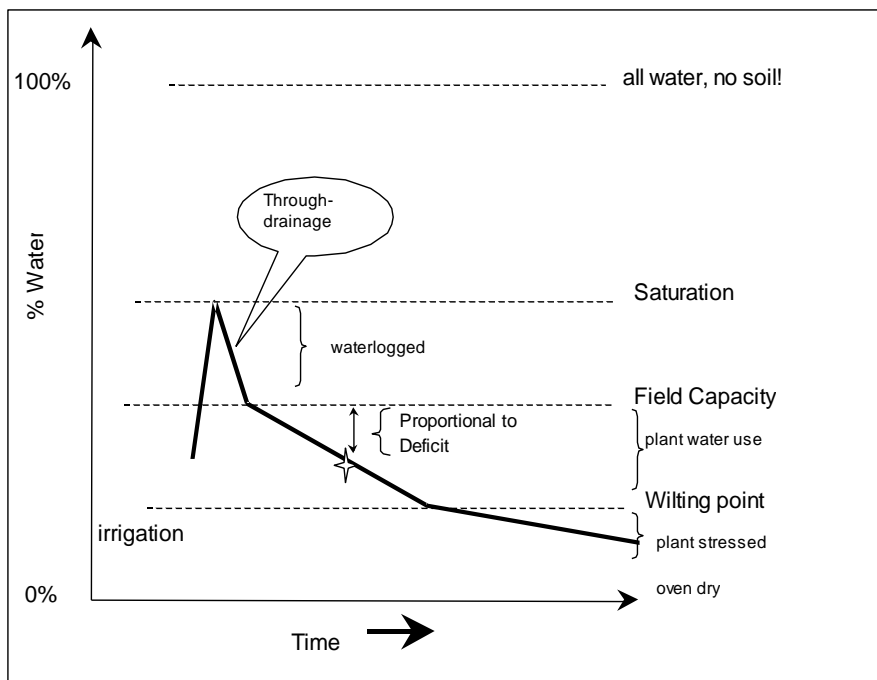

**Wilting Point** (WP) is the moisture content at which a particular crop is unable to extract any more water. Conventionally this is taken to correspond to a matric potential of  $-1500\text{kPa}$ , but it's really much more variable than that suggests. It's a property of soil type and crop type, and can vary between about 0.04 for sandy soils to 0.22 for clay soils. (Data for organic soils is not available).

**Dry** is zero moisture content.

**Available Water Capacity** is the difference between Field Capacity and Wilting Point.

**Water Deficit** is the amount of irrigation water or rainfall (mm) that has to be added to a soil profile in order to bring it back up to field capacity.

The size of the water deficit will depend on the depth of the soil profile that it relates to (usually taken as some function of the crop rooting depth).

This example shows deficit versus water content for a shallow sandy clay loam.

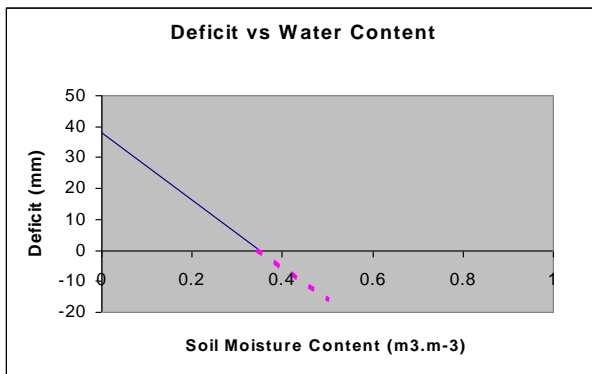

---

## Water Deficit Calculation for ThetaProbes

Water Deficit is calculated using the formula

$$D = R * (FWC - VWC)$$

where

R =	Rooting depth
FWC =	Field water capacity
VWC =	Calculated volumetric water content

# Water Deficit Calculation for Profile Probes

For a Profile Probe, water deficit is the sum of water deficits calculated for each sensor included within the rooting depth:

$$D = (FWC_1 - VWC_1) * d_1 .. + (FWC_n - VWC_n) * (d_n - d_{n-1}) + D'$$

where

- N                      Number of the deepest sensor contained within the rooting depth
- FWC<sub>1</sub>, FWC<sub>n</sub>        Field water capacity at first and n<sup>th</sup> sensors
- VWC<sub>1</sub>, VWC<sub>n</sub>        Volumetric water content at first and n<sup>th</sup> sensors
- d<sub>1</sub>, d<sub>n</sub>, d<sub>n-1</sub>        Depths of first, n-1<sup>th</sup>, n<sup>th</sup> sensors
- D'                      Additional deficit for soil below the nth sensor, calculated as below

If the rooting depth is less than the depth of the deepest sensor

$$D' = (FWC_{n+1} - VWC_{n+1}) * (R - d_n)$$

where R = Rooting depth.

If the rooting depth is greater than the depth of the deepest sensor

$$D' = (FWC_n - VWC_n) * (R - d_n)$$

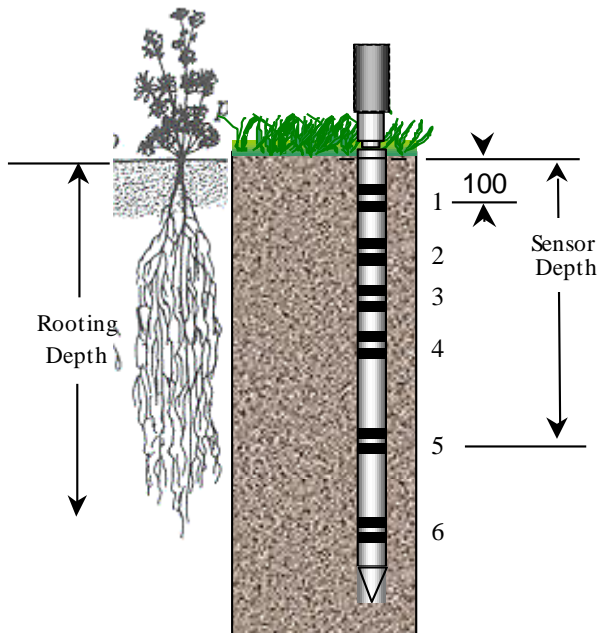

# Field Water Capacity Values

Field Water Capacity values are given for several soil types. These values can be entered in the 'Field Capacity' option of the Data menu. This is needed if you want the meter to display mm deficit.

You will also need to enter a value for Root Depth.

---

## Standard Soil Types

The following are tables of Field Water Capacity values for standard soil types:

---

**WARNING: USE EXPERIMENTALLY DETERMINED FIELD CAPACITY VALUES WHEREVER POSSIBLE - see Calculating Field Capacity.**

---

Defined at a tensiometer reading of: Commonly used in :	Volumetric Field Capacity	
	0.05 bar	0.15 bar
	UK & Europe	USA
CLAY	43.4%	42.2%
SILTY CLAY	40.5%	39.0%
SILTY CLAY LOAM	38.0%	36.0%
CLAY LOAM	35.9%	34.0%
SANDY CLAY LOAM	34.0%	31.0%
SANDY SILT LOAM	33.5%	29.9%
SILT LOAM	34.5%	31.0%
SANDY LOAM	27.5%	23.2%
LOAMY SAND	22.0%	17.0%
SAND	13.9%	8.2%

*Table by courtesy of Justin Smith of Turftrax Group Ltd*

Enter the Field Capacity of the soil closest to your soil.

---

**Note: These are average values. Individual soils will vary dependent on particle size, organic matter and compaction.**

---

If you do not know what soil type to use - see Identifying Soil Types, page 95 - or better still, determine the Field Capacity experimentally - see Calculating Field Capacity on page 96.

Owing to the variable nature of **organic soils** we are unable to recommend even a "standard" value for Field Capacity. Some irrigation consultants will advise you **not to record mm deficit unless you can confidently measure and interpret your own soil's Field Capacity.**

# Identifying Soil Types

Adapted by courtesy of the U.K. Ministry of Agriculture, Food and Fisheries.

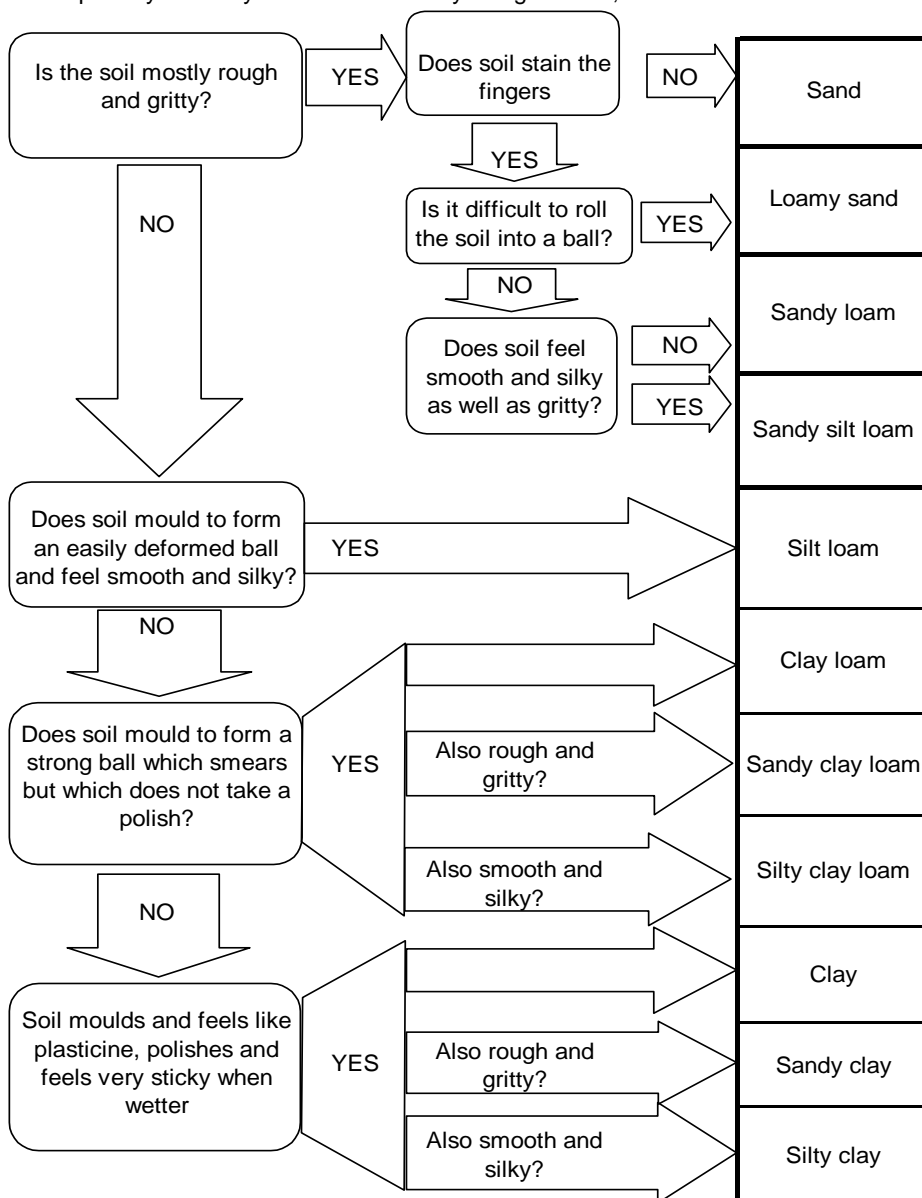

---

# Calculating Field Capacity

There are two methods for estimating Field Capacity:

1. Interpretation of field measurements
2. Laboratory measurements

## Field Measurements

To determine a field's natural capacity, it is necessary to collect a series of soil moisture profile readings before, during and after a thorough wetting-up of the soil. Unless time is of the essence, this is best done by a heavy, prolonged rainfall or by a complete field irrigation<sup>2</sup>. From the collected data set, construct a graph of soil moisture against time for each profile depth. For the upper soil profiles (0-40cms) the Field Capacity can usually be interpolated relatively easily from the graph as the level of soil moisture at which drainage stops and normal evaporation and transpiration losses take over. In certain soils or where drainage is restricted by a natural obstacle, - such as a high water table, plough panning, or a saturated clay substrate – it will be necessary to graph the individual sensor readings, not the summed total.

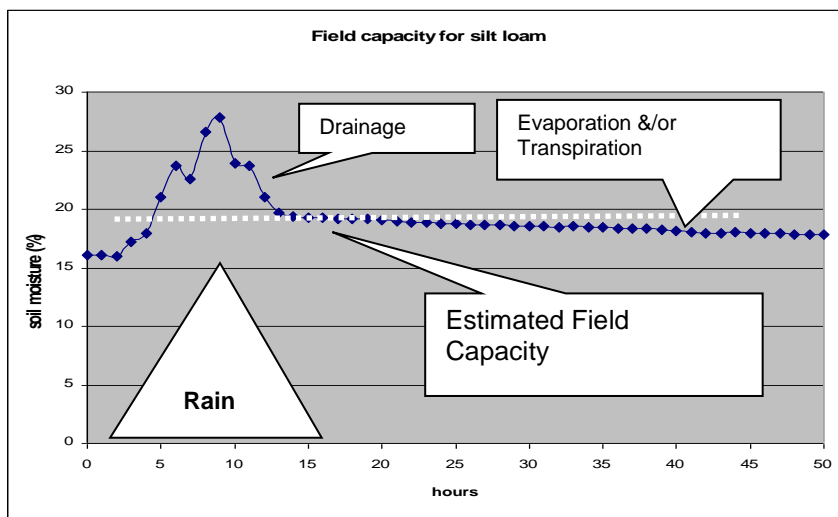

---

<sup>2</sup> It is tempting to simply wet-up the area around the sensors, if however, the readings are to be used as the basis of field scale interpretation, this can create an imbalance that will only be corrected when the field is naturally over-filled again.



For the lower soil profiles the interpretation is often not so clear, because the rate of infiltration from the soil profile directly above may not be great enough to cause field capacity to be exceeded. In that case, use the maximum soil moisture level encountered as an estimate of the Field Capacity.

## Laboratory Methods

Take an undisturbed soil core from each soil profile, and saturate. Allow to drain, and when drainage has stopped, weigh. Measure the volume of each sample, and then oven dry. Finally weigh again. The field capacity is equal to the difference in weights of each sample divided by its volume.

In Europe “when drainage has stopped” is determined by placing the saturated sample on dry soil or a wad of dry filter papers, and allowing it to drain for 2 hours. In America, it is taken to be the soil moisture content when the soil water potential,  $\phi_w$ , has fallen to  $-33\text{kPa}$  ( $-1/3$  bar).

---

# Available Field Water Capacity

**Available Water Capacity** is the difference between Field Capacity and Wilting Point.

Available Water  
% by Volume (mm/100 mm depth)

	Topsoil	SubSoil
Sand	8	5
Loamy sand	12	9
Sandy loam	17	15
Sandy silt loam	19	17
Silt loam	22	21
Clay loam	18	15
Sandy clay loam	17	15
Silty clay loam	18	15
Caly	18	15
Sandy clay loam	17	15
Silty clay loam	18	15
Peats	35	35

*Source: MAFF(1984) Soil Texture Leaflet 895*

This table contains average figures from a range of values for each texture. the range depends on the variation in particle size, organic matter and compaction.

Note: These are average values. Individual soils will vary dependent on particle size, organic matter and compaction.

Some irrigation consultants will advise you not to record mm deficit unless you can confidently measure and interpret your own soil's Field Capacity.

# Finding the Refill Point

The following is reproduced by courtesy of Research Services New England.

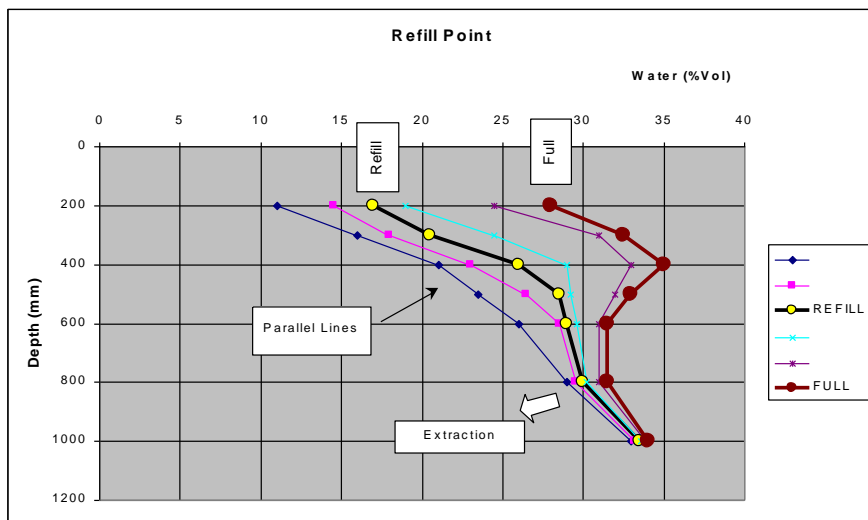

When the moisture content is maintained in the "optimum zone" the drying cycle line on a graph of depth vs. water content appear to change in a "Y" shape.. That is to say, the majority of the water will be extracted in the top 400 mm of soil, with some extraction taking place below. This will always represent a plant extracting water under an "optimum working environment".

When a soil gets near to the refill point, there are three distinctive changes:

1. The extraction lines on the depth graph become parallel.
2. There is usually a sudden deeper extraction of water in the soil profile.
3. Combined with the above two symptoms, there is usually a decline in the daily water use of the crop.

The refill point may change through the season. A potato grower interested in scab control may only want to dry down to a soil moisture deficit of 10-20 mm (depending on soil type), during the high scab risk period. This is commonly less than half of the technical refill point. An apple grower may wish to stress the crop beyond the refill point to stop or slow down shoot growth, at certain times of the year.

The "Full" and "Refill" points can also be determined from the time graph from the change in slope - see the diagram on page 91.

# Glossary

- Device ID** A unique number between 0 and 255. This will default to 0 when the meter is reset, but the user is able to modify this at any time to distinguish between different sensors being measured. The current value is recorded with each reading recorded in the meter.
- Equitensiometer** A sensor for soil matric potential - the negative pressure (or suction) required to extract water from between the matrix of soil particles. It is an important indication of plant water stress. The value of soil matric potential measured depends mainly on the quantity of water present and the make up of the soil, though it is also affected by temperature and salinity. It consists of a precision soil moisture sensor (a ThetaProbe) whose measuring rods are embedded in a porous material (the equilibrium body). This material has a known, stable relationship between water content and matric potential. When the probe is inserted into the soil, the matric potential within the equilibrium body rapidly equilibrates to that of the surrounding soils. The water content of the matric material is measured directly by the ThetaProbe, and this can be converted into the matric potential of the surrounding soil using the calibration curve supplied with each *Equitensiometer*. The HH2 Moisture Meter only reads Equitensiometers in raw mV. Each Equitensiometer linearisation table is unique. These are not stored in the HH2 in order to save memory.
- ECb** Bulk Electrical Conductivity. A measure of how well electric charge can be conducted through the bulk of the material, including all the solid and water pores.
- ECp** Pore Electrical Conductivity. A measure of how well electric charge can be conducted through the water pores. It is of interest as a means of measuring the concentration of ions present in the pore water.
- EQ1** Equitensiometer type EQ1. Soil matric potential sensor with one differential analogue output.
- EQ2** Equitensiometer type EQ2. Soil matric potential sensor with one differential analogue output.
- ERR\_....** Specific errors detected by the meter are given labels. When displayed by the PC software HH2Read a text description of the error is also shown.
- Engineering Units** These are the units of measurement of the reading shown on the display of the HH2. The units available depend on the sensing device.  
**Options:**  
mV, percentage of soil water by volume (%Vol), cubic metres of water per cubic meter of soil (m<sup>3</sup>.m<sup>-3</sup>), and mm deficit.

You may also save raw mV readings in addition to readings converted into other units.

- Field Capacity** Also called **Field Water Capacity (FWC)**. The maximum water content a soil can hold against gravity, once excess water has ceased to drain through it, surface run-off has ceased, and the water content has become relatively stable. This usually takes several days.  
Measurements in the laboratory are made by subjecting the soil to a standard suction pressure, normally specified as 0.05 bar in the UK and Europe and 0.15 bar in the USA. Tables of Field Water Capacity for different soil types are given above on page 94. Field Capacity Units are correctly stated as mm of water over a certain depth (e.g. 3mm over 0-70 cm).  
Another 'definition' or usage of 'field capacity' is "The wettest soil profile that can be regularly obtained after through-drainage has ceased". This is related to the idea that the field has reached its capacity or full point.
- Permittivity** An physical property describing the electromagnetic behavior of a material - used to determine both soil water content and conductivity.
- PR1** Profile Probe type PR1. Soil moisture sensing device with 4 or 6 differential analogue outputs, one for each sensor in the probe.
- PR2** Profile Probe type PR2.
- Plot ID** A unique letter between 'A' and 'Z'. This will default to 'A' when the meter is reset, but the user is able to modify this at any time to reflect a geographical area in which the meter is being used. The current value is stored with each reading which is recorded in the meter.
- Refill Point** The water content of the soil below which the plant exhibits some form of stress, and a drop in yield. Stress may be indicated by a drop in the daily use water. It depends both on soil and crop. One indicator of the refill point might be that roots start extracting water at a greater depth than normal. Some crops may be deliberately taken below the refill point to improve desired attributes.
- Rooting Depth** The depth of soil to which the roots extend. The soil depth that you are interested in for use in the water deficit calculation.
- Sample Number** A number between 1 and 2000. This will default to 1 when the meter is reset or all readings are erased, but the user is able to modify this number at any time. The sample number is recorded with the next reading to be recorded (not the last reading recorded). The sample number auto-increments (wrapping around at the end) after each reading is stored. Note: it is not incremented after each reading – only when a reading is stored.
- Wilting Point** The water content of the soil below which plants cannot extract any water from the soil.

# Index

## #

#, 7  
# key, 14

.

.LIN File Format, 69

## 2

25-pin to 9-pin RS232 Converter, 90  
25-way D-connector, 77  
25-way D-Connector, 74

## 9

9-pin RS232 Connector, 90

## A

a0 & a1, 67  
    about a0 & a1, 68  
Access tube, 5  
Accessories, 90  
Available Water Capacity, 92, 98  
Averaging, 7, 13

## B

battery, 5, 71  
Battery, 56, 71  
    Changing, 71  
Battery Change, 86  
Battery Low, 85

## C

C-HH2, 5  
C-HH2-DIN, 5  
Clock, 57  
Cold Boot, 79  
COM1, 54  
Com1 and Com2, 57

Connectors, 4  
Copyright, 2  
CSV, 63

## D

Data File Layout, 63  
Dataset Import Wizard, 61  
date, 57  
Day, Month, Year Order, 58  
Description, 4  
DIN to 25-pin RS232 Converter, 90  
Display is Blank, 80

## E

Equitensimeters, 45  
erase readings, 52  
error 0x80041004', 83  
Error code 7, 80  
Error Messages, 84

## F

Failed - Please erase data, 85  
Failed memory Full, 85  
Field Capacity, 22, 31, 96  
Field Water Capacity, 91  
Field Water Capacity Values, 94

## H

HH2, 5  
HH2BAT, 5  
HH2Read, 53  
HHRS2, 5

## I

Identifying Soil, 95  
Incorrect Readings, 81  
Installation, 53  
Ions, 43

## L

Linearisation Table, 70  
Linearisation Table Corruption, 85  
Linearisation Tables Format, 69  
Live Sensor, 85

## M

Maintenance, 74  
memory, 51  
Memory, 76  
Memory Failure, 86  
Meter will not respond, 82  
Meter will not sleep, 82  
ML1 or ML2, 20  
mm Deficit, 83

## N

Negative readings, 83  
No Sensor, 84, 86  
No Table, 86

## O

Options, 3, 8

## P

PC Communications Problems, 79  
PC Software, 24, 53  
Profile Probe  
  Errors, 82  
Profile Probe Options, 28  
Profile Probes, 25

## Q

Quick Start, 3

## R

READ, 59  
Reading the Equitensiometer, 47  
Reading the Profile Probe, 27  
Reading the WET sensor, 37  
Readings  
  Format, 63  
Readings can't be stored, 82

Readings Corrupt, 80, 86  
Refill Point, 99  
Remote Link, 54  
RS232, 77

## S

Saturation, 91  
Service, 74  
Settings Corrupt, 86  
Sleep, 7  
Software, 24, 53  
Soil Set Up, 22, 30  
Soil Type, 21  
Special soil calibration tables, 41  
Specifications, 75  
Store? prompt missing, 80  
Sys Error, 84  
Sys Error', 80

## T

Table hi, 84  
Table Lo, 84  
Table Status, 56  
Tajimi, 5  
Tajimi to 25-pin RS232 Converter, 90  
Technical Reference, 75  
Technical support, 89  
Temperature  
  compensation, 43  
Terms and Conditions of Sale, 88  
ThetaProbe Options, 19  
ThetaProbes, 16  
time, 58  
Too High, 86  
Too Low, 87  
Tools Menu, 59  
*Trouble Shooting*, 55  
Troubleshooting, 79

## U

Unpacking, 5

## V

Version, 54

## **W**

Warranty and Service, 88  
Water Deficit, 42, 91, 92  
Water Deficit Calculation for Profile  
    Probes, 93  
WET Options Summary, 39  
WET sensor, 79

WET sensor error, 79  
WET Sensors, 35  
Wilting Point, 91

## **Z**

Zero Readings, 81